



# 2025 WELCOME HOME

**FIRST CLASS REISEMOBILE**  
MADE IN GERMANY







DEAR  
FRIENDS!

Be inspired by elegant designs, sophisticated technical features and First Class equipment options. Send your holiday dreams on a journey and discover the world of First Class motorhomes.

**First Class - made in Germany.**

Real motorhome enthusiasts have come together in Schlüssel-  
feld near Bamberg to realise your luxury dream on wheels.  
We combine state-of-the-art production techniques with  
traditional craftsmanship to create vehicles in a class of their  
own. Our aim is to exceed your expectations in every respect  
- we have only achieved our goal when you are completely  
delighted with your MORELO First Class motorhome.

*Robert Gings*

*Reinhold Gies*



# HOME IS, WHERE YOU ARE. WITH MORELO.

**Because we do not just build motorhomes.**

We live First Class living comfort on wheels.

Our many years of experience are the basis - only enthusiasm is responsible for that little bit extra...

Curtain up for the MORELO family!

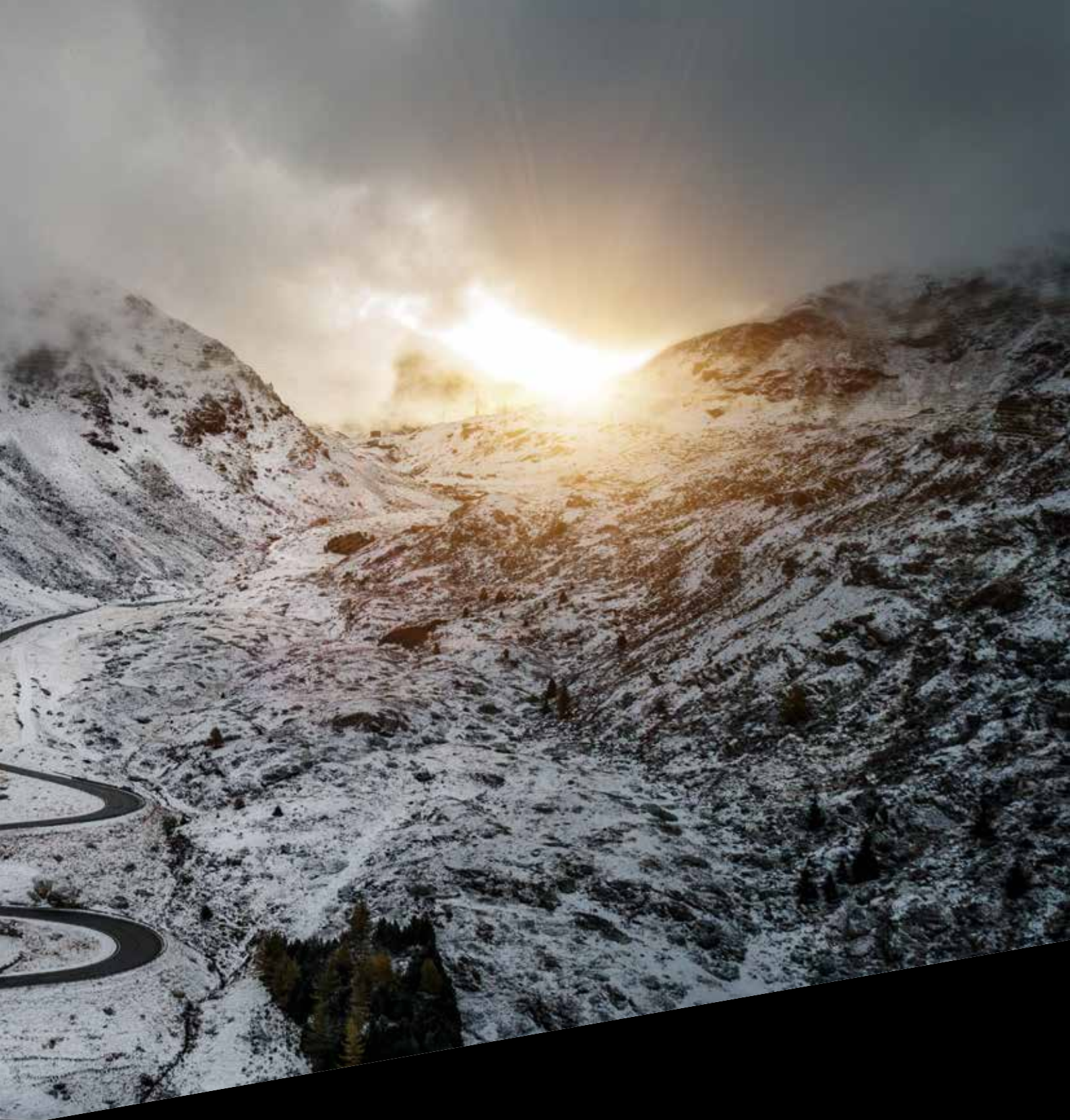

**06 / LOFT**  
THE ENTRY LEVEL

**22 / LOFT PREMIUM**  
THE SPACE MARVEL

**38 / LOFT ALKOVEN**  
THE FAMILY VEHICLE

**40 / PALACE**  
THE BESTSELLER

**56 / EMPIRE LINER**  
THE EXCLUSIVE

**72 / GRAND EMPIRE**  
THE FLAGSHIP

A man with glasses and a beard, wearing a plaid shirt, is driving a motorhome. The interior of the motorhome is visible, including the steering wheel and dashboard. The view through the large windows shows a scenic mountain landscape with green hills and a road winding through the valley. The sky is bright and slightly hazy.

# MORELO LOFT

**Cosy, just like a LOFT should be.** And not lacking manoeuvrability as the new entry into the luxury class - despite its 7.99 metres. This makes it extremely easy to embark on new adventures in a highly comfortable way, of course depending on your individual wishes. Many chassis and layout options make this possible.

MORELO  
LOFT



**Gudrun and Reinhard Bielefeld** are convinced motorhome enthusiasts and are often not to be found at home for months at a time. And why should they? With the LOFT, they are independent and able to set off spontaneously at any time without having to make any sacrifices. But what the gregarious couple loves the most is to enjoy the homely feeling in their MORELO at the end of an eventful day.

AWNING ON BOARD  
- HIDDEN IN THE  
ROOF PROFILE

FLAPS WITH  
INNER HINGES

# STRIKING APPEARANCE

**Actually, we always look ahead.** But with these bus-inspired rear-view mirrors, looking backwards is also pure pleasure. The new LOFT is dynamic and sporty, with a curved windscreen, full-length rear light and sun protection thanks to the integrated awning (optional). Unmistakably MORELO.

## Dimensions

Width: **2,40 m**

Length: **7,99 - 8,69 m**

Height: **3,49 m**



MORELO  
LOFT



COMPLETE  
LIGHTING  
CONCEPT IN LED

Highlight layout

LOFT 78 L

Choose from eight model options and customise your LOFT according to your preferences.

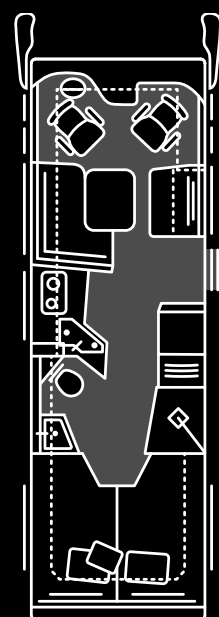

## Technical specifications

Chassis: **IVECO Daily 65 C 18**

Emission class: **EURO VI e**

Engine: **3,0 l**

Power: **129 kW / 175 hp**

Technically permissible max. weight: **6.500 (7.200) kg**



# EXTREMELY COMFORTABLE

**You drive - we take care of the rest.** So, feel free to take a seat in the front living area, treat yourself to a refreshing drink from the cooler compartment or take a look at the nav system (optional). Driver's cab? Sure, with everything that goes with it. Just in a cosy style.

- + **Dashboard with ambient lighting**
- + **Pilot seats, swivelling, with belt system**
- + **Luxury cab suspension seats** (optional), with air suspension, lumbar support & seat heating
- + **Optimised sound insulation in the engine compartment**
- + **Bus-style rear-view mirrors**
- + **Premium cockpit with leather covering**

**MORELO  
LOFT**



**Glove compartment**

Everything you need is always within reach with the spacious glove compartment.



**Navigation system**  
(optional) a combination of radio, nav system, MORELO Connect.

# A MODERN HOME

## Sunshine at heart – whether it's storming or snowing.

This comes easy in the LOFT: highly comfortable upholstery meets modern design and new materials. Handleless wall units and pleasant lighting contribute even more to a cosy atmosphere. The LOFT is your mobile retreat in any weather.

### Seating comfort

The seating group with ergonomically shaped upholstery offers seating comfort in a class of its own.

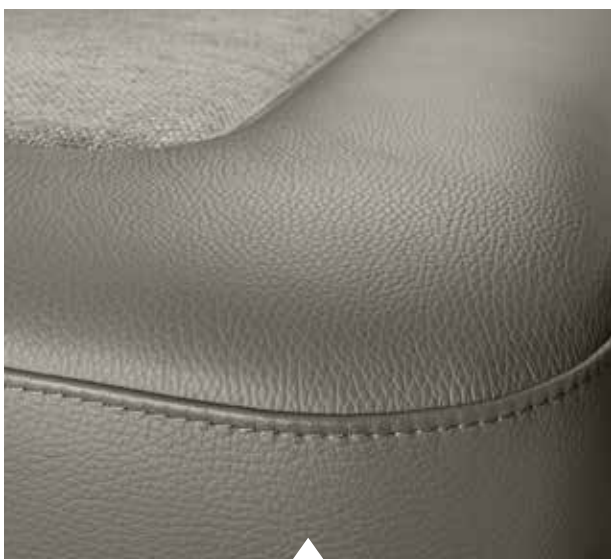

### Upholstery

A wide variety of upholstery for full comfort and every taste.



**MORELO  
LOFT**



- + Wonderfully comfortable upholstery
- + Noble surfaces
- + Torsion-resistant lightweight material
- + Spacious drawers
- + Indirect ambient lighting
- + Plenty of room to move
- + Extendable, single-leg table
- + Bar seating group (optional)



# KITCHEN MARVELS

**Why do without?** With this kitchen in the MORELO LOFT, you can make the most of everything: In addition to the standard household refrigerator - with freezer compartment, of course - and oven, the two-burner luxury gas hob is always at your service. The powerful appliances make cooking a real pleasure. Drawers, cupboards, space for chopping - everything cleverly thought out.

- + **Double sink** with covers
- + **Domestic oven** (optional) with microwave
- + **Deep wall units**
- + **Full-extension drawers**
- + **Pull-out waste bin**
- + **Dishwasher** (optional)



**Nespresso capsule machine** safely stowed away (optional).



**MORELO  
LOFT**



**Wall units**  
The illuminated wall units offer plenty of extra storage space.



**Two-burner luxury gas hob** flush, with automatic ignition and glass cover.



**BSH domestic refrigerator**  
172 liter refrigerator with 15 liter freezer compartment and soft-close door.



# WELL-BEING MADE EASY

**This bathroom is generous with its amenities.**

For example, you can look forward to the shower with glass door and LED lighting, plenty of space and the atmospheric ambient lighting. In the studio bathroom, the toilet and washbasin are located on the driver's side, while the shower with two swing doors is on the passenger side.

- + **Ceramic flush toilet**
- + **Large mirror cabinet** with lighting
- + **Easy-care washbasin**
- + **Single lever mixer tap in chrome**
- + **LED spotlights and indirect lighting**, dimmable
- + **Skylight with fly screen** and pleated shade blind





**Shower with real glass door and stylish lighting.**



**Generous storage options** provide plenty of space and shine thanks to surfaces that are easy to clean.



**Washbasin** with seamlessly integrated washbasin, push-open valve and household drain.



# SWEET DREAMS

**First class sleeping comfort** also means that you have a free choice of bed options. Offered are the twin bed as illustrated, the queen-size bed accessible from both sides or the French bed. All with cold foam mattresses for a restful sleep, of course. Do you fall asleep best while watching TV? No problem!



**MORELO  
LOFT**



**"THANKS TO THE  
HIGH-QUALITY BEDS,  
BACK PAIN IS  
ABSOLUTELY NOT  
AN ISSUE."**

*Gudrun Bielefeld*



**Lean back and relax**  
in either the spacious queen-size  
bed or the French bed.



**Closet**  
with LED  
lighting.

DYNAMIC REAR  
DESIGN WITH LED  
LIGHTING CONCEPT



"BEING ON THE ROAD  
MEANS FEELING FREE.  
WITH THE MORELO  
LOFT, WE DO NOT HAVE  
TO COMPROMISE ON  
ANYTHING."

*Dei-Oscar Bütelefeld*



# SPACE FOR HOBBIES

**Even loading is fun.** When wanderlust gets to us, we pack up our belongings: e-bikes go into the rear garage. Fortunately, there is no question of "heaving" with this low loading sill. Afterwards we load up the cupboards, drawers and shelves for quick access - after all, there is plenty of storage space. Then you are ready to go.

**MORELO  
LOFT**

**ROOFLIGHTS  
ENSURE IDEAL  
INDOOR CLIMATE**



**ELECTRICALLY  
EXTENDABLE  
STEP**



**Outside hatches without any thermal bridges**  
Important items are quickly to hand and well protected from the heat and cold.



**Rear garage**  
Convenient loading and unloading thanks to the low sill.



**The LOFT PREMIUM: for more space in the kitchen and bathroom.** The LOFT's big brother offers more of everything. The result: more flexibility, more comfort and more enjoyment. Eight model options make your individual travel dreams come true.

MORELO  
LOFT  
PREMIUM

# MORELO LOFT PREMIUM



**Simone and Jochen Reimann** are adventurous and enjoy the flexibility that their MORELO LOFT PREMIUM gives them. To pursue their hobbies while travelling, they need plenty of space - and that's exactly what their MORELO can offer. Whether it is scuba diving equipment or bicycles - there is plenty of storage space and everything can come along. In their MORELO, Simone and Jochen have found the freedom they have always been looking for.

STYLISH REAR  
WITH FULL-LENGTH  
TAIL LIGHT



# THE BIG BROTHER

**The family continues to grow.** Join us in welcoming the big brother of the popular LOFT: the MORELO LOFT PREMIUM. And its name lives up to its promise, because there is even more in it for you. More kitchen, more bathroom, more payload, more lighting design ... This is where living pleasure meets driving pleasure without any limits. Are you ready?

## Dimensions

Width: **2,40 m**

Length: **8,44 - 9,14 m**

Height: **3,49 m**



ROOF RESISTANT  
TO HAIL

MORELO  
LOFT  
PREMIUM



CURVED  
WINDSHIELD

Highlight layout

LOFT PREMIUM 86 LB

Choose from eight model options and customise your LOFT Premium according to your preferences.

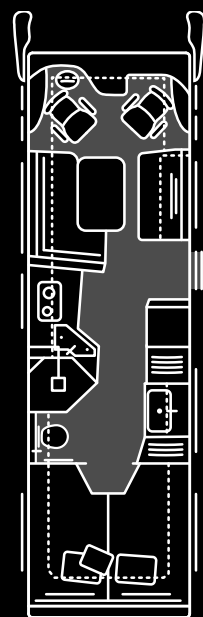

## Technical specifications

Chassis: **IVECO Daily 70 C 18**

Emission class: **EURO VI e**

Engine: **3,0 l**

Power: **129 kW / 175 hp**

Technically permissible max. weight: **7.490 kg**



# CONVENIENT CONTROL CENTER

**Living in the driver's cab.** Are you still driving or already taking pleasure? With the MORELO LOFT PREMIUM, this question does not even arise. Because the elegantly equipped cockpit with cooler compartment is an inherent part of the living space. And because manoeuvrability means everything, the swivel pilot seats can be adjusted to suit your needs and conveniently be integrated into the habitation area.

- + **Dashboard with ambient lighting**
- + **Pilot seats, swivelling**, with belt system
- + **Luxury cab suspension seats** (optional), with air suspension, lumbar support & seat heating
- + **Optimised acoustic insulation** in the engine compartment
- + **Bus-style rear-view mirrors**
- + **Premium cockpit** with leather covering
- + **Removable steering wheel** (optional)



MORELO  
LOFT  
PREMIUM

"MY HOLIDAY  
STARTS AS SOON  
AS I TAKE MY SEAT  
BEHIND THE WHEEL."  



**Refrigerated bar compartment** (optional) works in combination with the air conditioning, can be switched on and off at any time.



**Multifunction steering wheel** (optional) Convenient control of many vehicle functions and media.

# MORE SPACE FOR LIVING

**Uncompromising living pleasure.** You can lean back and unwind in this space marvel. The LOFT PREMIUM offers you, and everything you do not want to miss on your journey, plenty of space. This is ensured by the generous storage space and cosy seating options.



**Electrically lowerable Smart TV (optional)**

Linear television or streaming - both are possible with this 32" TV.



**MORELO  
LOFT  
PREMIUM**



- + **Electric drop-down bed**  
possible above dashboard
- + **Handleless wall units**  
with plenty of space
- + **Indirect ambient lighting**
- + **Generous feeling of space**
- + Optional **bar seating group**
- + **All windows with fly screens**  
and pleated blackout blinds



# CULINARY EXCELLENCE WITH EVERY INCH

**Longer kitchen.** If you want to spoil your loved ones with culinary delights in the MORELO LOFT PREMIUM, you have one thing above all: plenty of space. Compared to the LOFT, we have added a whopping 15 centimetres. On top of that, the LOFT PREMIUM comes with excellent household appliances, a practical interior and a practical pull-out-cabinet for exquisite oils and spices.

- + **Deep, handleless wall units**
- + **Two-burner luxury gas hob**
- + **Double sink** with covers
- + **Pull-out waste bin**
- + **Domestic fridge**
- + **Domestic oven** (optional)
- + **Dishwasher** (optional)



**Full-extension drawer  
in metal construction**

Food and cooking utensils are easily accessible and safely stowed away.



**MORELO  
LOFT  
PREMIUM**



**Pull-out-cabinet**

Bottles and small items are stowed and within easy reach.



**BSH domestic oven** (optional)

for the finest roasts and delicious cakes - or reheated food thanks to the microwave function.



**BSH domestic refrigerator**

172 litre refrigerator with 15 litre freezer compartment and soft-close door. Very energy efficient.

# RISE & SHINE

## Step into your personal oasis of well-being.

With the shower and toilet on the driver's side, the result is a spacious room concept –and the principle of "more of everything" runs through the entire bathroom. Well, almost: The ceramic toilet can also flush more sparingly, depending on how long the button is pressed.

- + **Spacious shower** with real glass door
- + **Ceramic flush toilet**
- + **Large mirror cabinet**
- + **Skylight with fly screen** and pleated blackout blinds
- + **Easy-care washbasin**



**MORELO  
LOFT  
PREMIUM**



**Shower unit**  
with real glass  
and LED lighting.



**Shower head**

with easy-care surfaces for a shower experience just like in the bathroom at home.



**Ceramic toilet**

with economical flush system: you determine the amount of water with the touch of a button.



# MORE SPACE FOR BEAUTIFUL DREAMS

**Also a benefit for night owls.** On average, we sleep for 24 years of our lives. We should not tolerate any compromises when it comes to comfort. Good news: you don't have to! The MORELO LOFT PREMIUM impresses with a wide selection of beds, a high level of sleeping comfort and plenty of storage space. And of course with the right light for reading or a movie night. As an option, you can also choose the multi-zone EvoPore mattresses with a "water gel" top layer including comfort slat base - a dream.

**BED OVERVIEW** / 124 - 125



**MORELO  
LOFT  
PREMIUM**

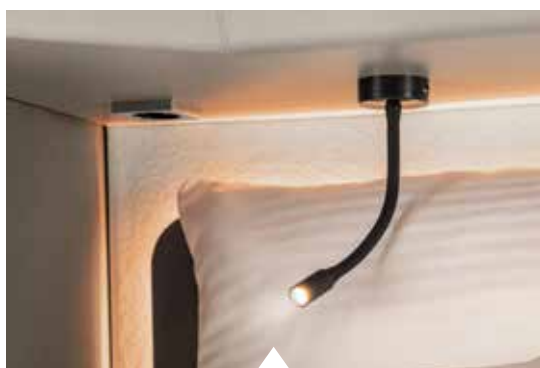

**Gooseneck lamp**  
with USB socket in the pedestal.

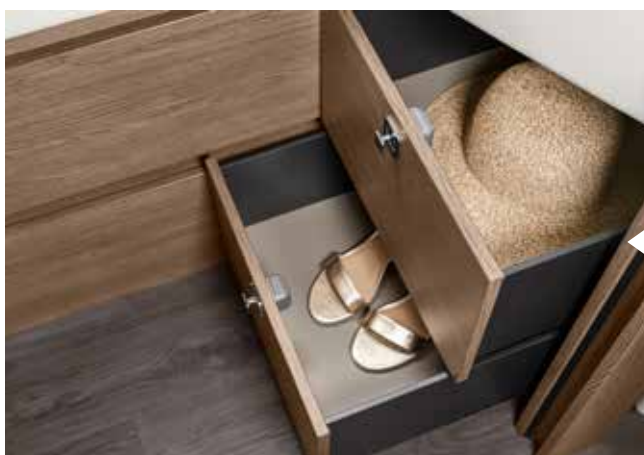

**Drawers**  
**under the bed**  
offer maximum  
storage space.



REAR WALL WITH  
FIBREGLASS COMPOUND  
SANDWICH DESIGN

ENTIRELY WOOD-  
FREE EXTERIOR  
STRUCTURE

# SPACE FOR ADVENTURES

**You bring the desire to travel, we bring the necessary storage space.** Heated double floor, cold-bridge-free storage compartment flaps, rear garage: The MORELO LOFT PREMIUM offers plenty of space for your luggage and everything you need for your adventure. Bikes or a scooter for a local excursion can be stowed away in the spacious and easily accessible rear garage.

FRONT WITH HIGHLY  
STURDY FIBREGLASS  
COMPOUND

MORELO  
LOFT  
PREMIUM



"THE LOFT PREMIUM  
IS THE PERFECT  
COMPANION FOR ALL  
OUR ADVENTURES."

*Singue  
Reinam*



**Outside hatches without any thermal bridges**  
Everything is accesible in the dobule floor.



**Rear garage**  
Conveniently accesible on both sides via large doors:  
Everything fits here.

ALCOVE  
CONSTRUCTION  
IN GRP

EXTRA HIGH  
DOUBLE FLOOR



# LOFT ALKOVEN & LOFT PREMIUM ALKOVEN

**Classic construction, but completely reinterpreted:** Our new MORELO LOFT ALKOVEN / LOFT PREMIUM ALKOVEN is the perfect motorhome for families thanks to its high-quality materials, well-designed body, first class comfort and ample seating options. The only thing you decide is where you want to go.

- + **Convenient passageway** from the living area to the driver's cab
- + **Higher tank volume** than the LOFT
- + **Higher double floor** with 460 mm
- + **Outside hatches** with inner hinges

**MORELO  
LOFT  
ALKOVEN**

**MORELO  
LOFT  
PREMIUM  
ALKOVEN**

**ORIGINAL IVECO  
DRIVER'S CAB**



**Looks good from every angle**

The rear design looks dynamic and striking thanks to LED tail and brake lights.



**Good visibility**

Full LED low beam and high beam with LED daytime running lights for a safe journey.



**You love it, we love it.** Because the MORELO PALACE is made for new adventures. It combines fun travelling with width and technology with comfort. But because "more" is always better, we have made some adjustments: Large storage compartment flaps with a high double floor, larger capacities. And, you know us: we have not spared on clever ideas in the interior either.





MORELO  
PALACE

# MORELO PALACE



**Norbert and Heike Vettel prioritise driving comfort.** As they spend a lot of time at the racetrack, their MORELO PALACE is just right for the Vettels: The combination of modern design and generous space offers them everything their heart desires. But the icing on the cake for them is also the unrivalled technology, which is way ahead of its time and leaves nothing to be desired.

EXTRA-WIDE  
ENTRANCE DOOR WITH  
COMBINATION LOCK

HANDLELESS  
FLAPS

# FORM & FUNCTION

**Clear lines, strikingly dynamic design.** The new MORELO PALACE impresses with its masculine appearance, which can be further emphasised by the wider front axle (wide axle, optional). And once the step has been electrically extended, the only thing left to do is to get in.

## Dimensions

Width: **2,45 m**

Length: **8,69 - 9,79 m**

Height: **3,58 m**



**MORELO  
PALACE**

**LED HEADLIGHTS  
AS STANDARD**

**ILLUMINATED  
MORELO FRONT LOGO  
(OPTIONAL)**

Highlight layout

**PALACE 88 LB**

Choose from twelve model options and customise your PALACE according to your preferences.

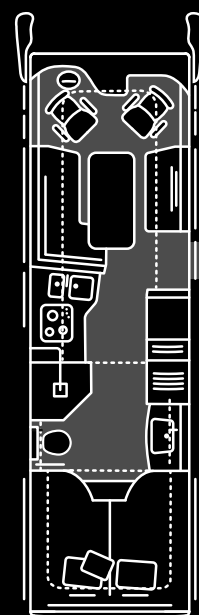

## Technical specifications

Chassis: **IVECO Daily 70 C 18**

Emission class: **EURO VI e**

Engine: **3,0 l**

Power: **129 kW / 175 hp**

Technically permissible max. weight: **7.490 kg**



# PREMIUM COCKPIT

**It has everything a driver's heart desires.**

And more: the intelligent blackout blind system on the windscreen and side windows provides with the necessary privacy during breaks. Thanks to the narrow A-pillars and the curved panoramic windscreen, you have an even better view and driving noise is reduced to a minimum.

- + **Cockpit with ergonomic seats**
- + **Removable steering wheel** (optional)
- + **Cooling compartment**
- + **Flush cab side windows** made of insulating glass with fly screen and pleated blackout blind

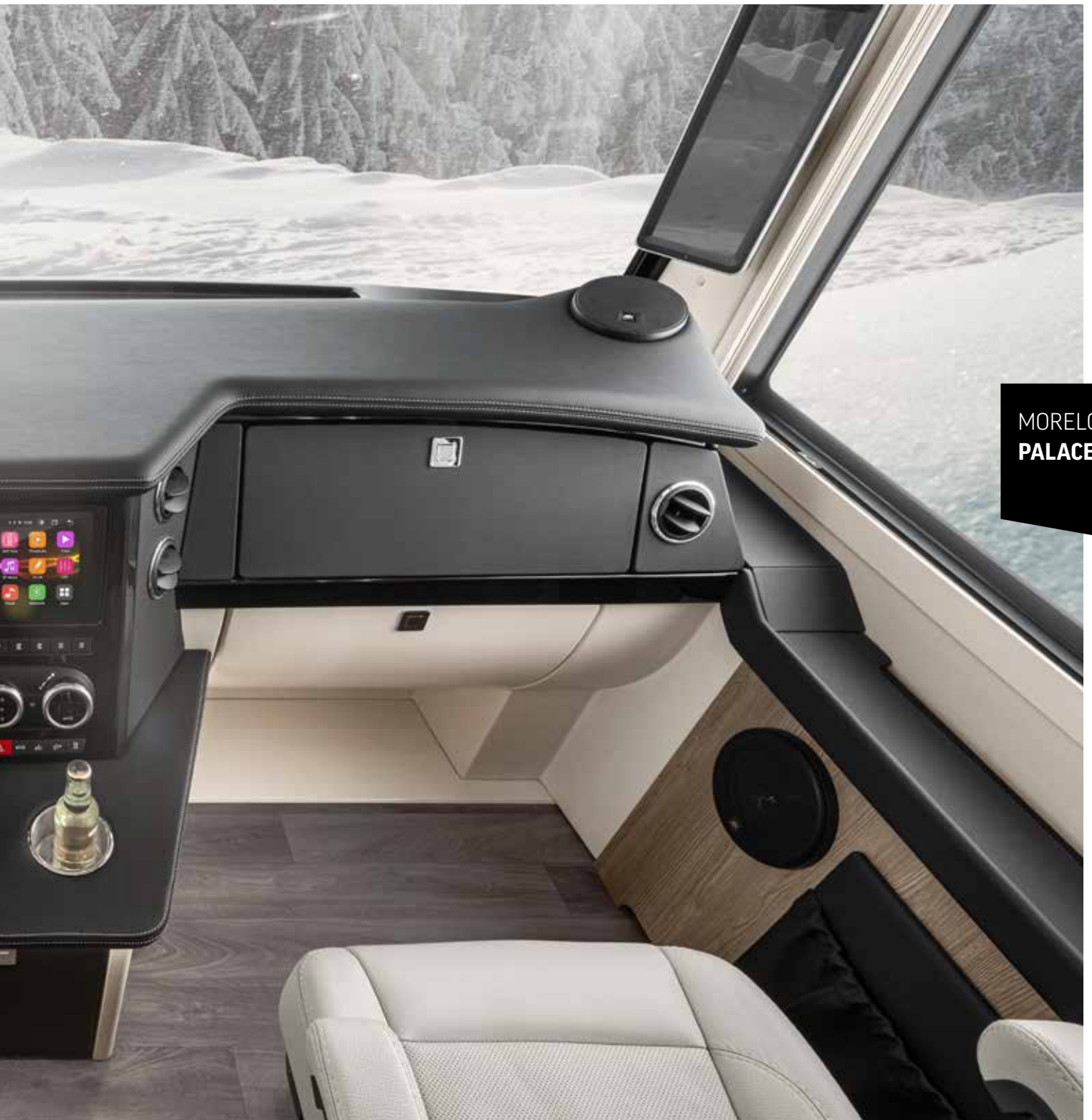

**MORELO  
PALACE**



**The steering wheel**  
can be removed in  
a single movement.  
(optional)

# EVERYTHING NEATLY STOWED AWAY

**On the plus side, you have the widest living space in its class, extra-deep wall units and drawers underneath the seats.** So you can be sure of plenty of space. The clear lines and the new colour and lighting concept focus on what is really important: the comfortable view.



**Dyson V8 Absolute** (optional)  
This wireless powerhouse quickly ensures cleanliness again.





**MORELO  
PALACE**

**"ENDING OUR  
DAY IN THE COSY  
ATMOSPHERE OF  
OUR MORELO,  
SIMPLY MAKES US  
FEEL AT HOME."**

*Robert Vittel*



- + Spacious entrance area
- + Widest living space in its class
- + Elegant, clear lines
- + Voluminous storage space
- + Noble look
- + Impressive feel
- + Handleless wall unit fronts



"EVERYTHING IN THE  
MORELO PALACE IS  
CLEVERLY ORGANISED.  
COOKING BECOMES  
A PURE PLEASURE!"

*Heike Vöthel*

# TO SUIT ALL TASTES

**Real eye candy.** That is the kitchen in the MORELO PALACE. And it is practical as well. After all, it features high-quality BOSCH & Siemens household appliances, a double sink and soft-close drawers. Fresh food has its place in the spacious refrigerator - with a separate compartment reserved for vegetables, of course.

- + **Clever design**
- + **Practical pull-out-cabinet**
- + **Pull-out waste bin**
- + **Full-extension drawer**
- + with soft-close mechanism
- + **Single lever mixer tap in chrome**
- + **Indirect ambient lighting**





**BSH refrigerator**  
 172 litre refrigerator  
 with 15 litre freezer  
 compartment and  
 soft-close door.  
 Optional: 200 litre  
 refrigerator with  
 separate 60 litre freezer  
 compartment.



**MORELO  
 PALACE**



**BSH domestic oven**  
 for the finest roasts and  
 delicious cakes - or  
 reheated food thanks to  
 the microwave function.



**Double sink**  
 made of solid mineral material.



**Pull-out cabinet**  
 everything at a glance and easy to reach.



# COMFORT 24/7

**Bathroom in perfection.** This bathroom cannot really be improved, but we have done it anyway. Take the ceramic toilet, for example. The "flush" button is purely for draining, without any additional water filling. And because we want to offer you a tailor-made room layout, this dream bathroom is available in different versions, for example with a separate toilet room.

- + **Wardrobe** with LED lighting
- + **Spacious drawers**
- + **Wall panelling** in elegant stone look
- + **Mirror cabinet** with LED lighting
- + **Separate toilet room** (optional)
- + **Towel dryer radiator**
- + **Skylight with fly screen**  
and pleated blackout blind



**Large real glass shower,** optionally with EMPIRE rain shower.

**MORELO  
PALACE**

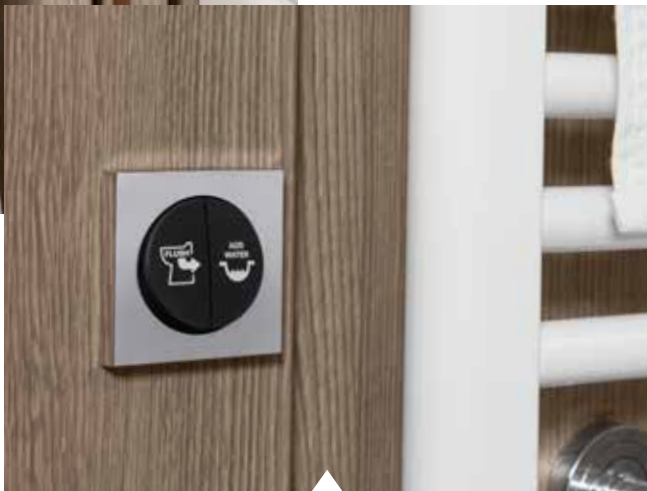

**Flush button**

water volume is determined by the length of time the button is pressed.



**Ceramic toilet**

with innovative flush button.



# DREAM RICH

**Early risers need to be strong now.** In this realm of dreams, staying in bed has its charm. Perhaps it is the EvoPore mattress with watergel topper or the stylish, practical pleated blackout blind. The comfortable bed of your choice will probably also play its part. Maximum comfort, that was the goal.

**BED OVERVIEW** / 124 - 125





**MORELO  
PALACE**

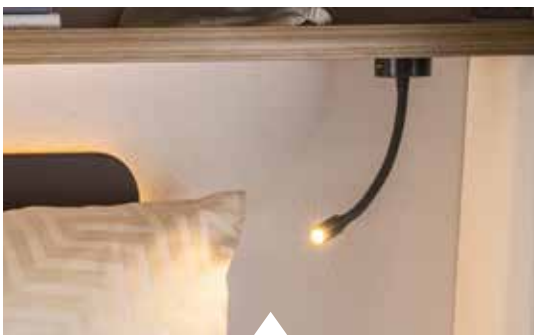

**Gooseneck lamp with USB port** allows you to lean back with a book and charge your smartphone at the same time.



**Sleeping area**  
The extra space for restful nights.

A white motorhome is shown from a rear three-quarter view, parked on a snowy road. The background consists of a dense forest of evergreen trees covered in snow. The motorhome has a license plate that reads 'SA PA 2025'.

FRONT AND REAR DESIGN  
IN THE TYPICAL MORELO  
DESIGN LANGUAGE.

# REALLY EVERYTHING CAN BE ON BOARD

**A storage space miracle.** Isn't it a wonderful feeling when everything, really everything, is stowed away? And not just somehow, but easily accessible and ready to hand. It starts with the car garage with its practical cable winch and does not end with the new, handleless outside flaps.

- + **Car garage with ramps and cable winch**
- + **Suitable lashing system**  
for cars in the rear garage
- + **Excellent accessibility**
- + **Additional storage space** in the double floor



**MIRRORCAM  
PERFECT FOR  
REAR VIEW**

**MORELO  
PALACE**

**HANDLELESS OUTSIDE FLAPS,  
ELECTRIC OPENING.**



**Central locking**  
everything is securely locked  
with one click.



**Storage space  
miracle**  
The transversal  
compartment can  
be conveniently  
accessed from  
both sides.

# MORELO EMPIRE LINER

**Exclusivity, style, comfort.** You can expect all this from a luxury motorhome like the MORELO EMPIRE LINER. But why be so modest? We do not just want to spoil you with one of the best First Class motorhomes, we want to give you something even more precious with the MORELO EMPIRE LINER: the good feeling of being at home.





**MORELO  
EMPIRE  
LINER**

DOUBLE-GLAZED REAL  
GLASS WINDOWS

ELECTRIC GARAGE DOOR  
WITH NEW MECHANISM

OUTSIDE FLAPS,  
ELEGANTLY INTEGRATED  
INTO THE SIDE WALL

# AN ATTRACTIVE EYE-CATCHER

**We are not really fans of superlatives.** Nevertheless, we have built one: The MORELO EMPIRE LINER, a motorhome in a class of its own that offers its passengers every conceivable comfort and looks breathtakingly beautiful at the same time. Incidentally, the "German Design Council" also thinks so and has therefore presented the EMPIRE LINER with the German Design Award. We are a little proud of that.

## Dimensions

Width: **2,55 m**

Length: **9,65 - 11,45 m**

Height: **3,79 m**

ESPECIALLY REINFORCED SIDE  
WALL AND ROOF THICKNESS  
(52 MM INSTEAD OF 42 MM)



MORELO  
EMPIRE  
LINER

AIR SUSPENSION  
ON FRONT AND  
REAR AXLE

Highlight layout

EMPIRE LINER 110 GSB

Choose from six model options  
and customise your Empire Liner  
according to your preferences.

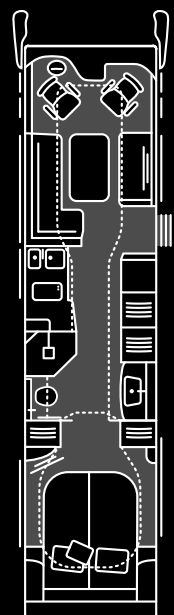
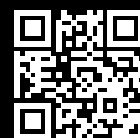

## Technical specifications

Chassis: **Mercedes-Benz Atego 1230 L / 1530 L**

Emission class: **EURO VI e**

Engine: **7,7 l**

Power: **220 kW / 299 hp**

Technically permissible max. weight: **11.900 kg / 15.000 kg**



# GOOD TO GO

**Get in and immediately feel at home.** Everything is where you expect it to be. The cockpit of the MORELO EMPIRE LINER offers well thought-out functionality with top-class living comfort. The raised seating position provides an overview and an all-round panoramic view of the road and landscape. Just take off and then the journey is the destination.



MORELO  
EMPIRE  
LINER



**Navigation system**  
Combination of radio,  
navigation system and  
MORELO Connect.

# TRAVELLING IN STYLE

**Why should you do without something that is an inherent part of your life?** For example, selected comfort, a habitation area with an exclusive ambience, elegant furniture, wonderfully comfortable seat upholstery, fine equipment details, underfloor heating and atmospheric lighting. You won't miss any of this in the MORELO EMPIRE LINER. Quite the opposite.

## Living comfort in a class of its own

You feel at home here,  
no matter where you are.



## More individuality

Do you prefer light-coloured leather?  
You have a free choice of interior design.





**MORELO  
EMPIRE  
LINER**



- + **Harmonious lighting concept**
- + **Modern design** with high-quality fittings
- + **Hot water underfloor heating**
- + **Satellite TV system** (optional)
- + **High-quality finish**
- + **Elegant panoramic skylight**
- + **Ergonomic seat cushions**
- + **Wall unit fronts** with deep-view effect



# INTERNATIONAL CUISINE? OF COURSE!

## **Gazpacho in Spain or wild salmon in Norway:**

The cuisine at the MORELO EMPIRE LINER is international and its fully equipped kitchen offers all the finesse needed to bring the regional culinary specialities to the table. Or home-style cooking like at home. Good flavour knows no boundaries. Especially not in a MORELO EMPIRE LINER.

- + **Three-burner gas hob**, flush, induction hob optionally available
- + **High-quality single-lever mixer tap** in chrome
- + **Drawers with soft pull-in** & cutlery insert
- + **Spacious wall units**
- + **Nespresso coffee capsule machine** with milk frother





**Dishwasher**  
(optional).



**MORELO  
EMPIRE  
LINER**

**Mineral worktop**  
with seamlessly  
integrated sink.



**Overhead glass cabinet**

Champagne and wine glasses stay exactly where they belong during the journey.



**BSH domestic refrigerator**

172 litre refrigerator with 15 litre freezer compartment and soft-close doors.



# WONDERFULLY REFRESHING

**Relaxed well-being in an ambience of understated luxury.**

Whether in Amsterdam or just outside Zurich, by the sea or in the mountains - with its elegant natural stone decor, elegant furnishings and ample space, the bathroom in the MORELO EMPIRE LINER leaves nothing to be desired.

Enjoy showering comfort like at home at any of your favourite travel destinations.

- + **Illuminated mirrors**
- + **Elegant washbasin**
- + **Pull-out towel rail**
- + **Towel dryer radiator**
- + **Wall panelling** in an elegant stone look
- + **Large wardrobe** with LED lighting



**Large real glass shower** with rain shower and hand shower.

**MORELO  
EMPIRE  
LINER**



**Single lever mixer tap** in chrome with pull-out.



**Ceramic toilet** with soft-close lid.

# SLEEPING IN YOUR OWN BED

**It is a good feeling to be at home.** With the EvoPore multi-zone mattresses including comfort slat base and ergonomic Watergel top layer, you can enjoy the feeling of sleeping at home every night. And while the starry sky twinkles in through the large panoramic roof window, you can already look forward to the next wonderful day of travelling in your MORELO EMPIRE LINER.



## Spacious wardrobes

offer enough room for your favourite items with their generous dimensions.





MORELO  
EMPIRE  
LINER



#### Queens bed

The queen-size bed is accessible from both sides, leaving room for two additional wardrobes. Comfortable size: approx. 163 x 208 cm.

#### Travelling dreams

Lean back, relax and dream of your next holiday adventures - you have more than enough space for this, whether in the queen or king-size bed.



**How about a little extra?**

The rear car garage in the GRAND EMPIRE even offers room for a Mercedes-Benz SLK / AMG GT or a Porsche 911.



# MOBILE GARAGE

**Space for up to 180 crates of mineral water.**

That is what the rear garage of the MORELO EMPIRE LINER offers - but who wants to travel with them? Bicycles, scooters or motorbikes are the preferred choice. Or would you prefer something a little more comfortable? There is also space for a Smart, Fiat 500 or Mini Cooper in the MORELO EMPIRE LINER.

REAR IN  
THE TYPICAL  
MORELO DESIGN



MORELO  
EMPIRE  
LINER

REAR WITH  
ELECTROMECHANICAL  
CLOSING SYSTEM

A POWERFUL CABLE WINCH  
TRANSPORTS THE CAR VIA  
TWO STABLE ACCESS RAMPS



**Storage compartment flaps**

Perfectly integrated into the side surface with access to the chassis, fuel tanks, batteries, waste water connections and technology (model-specific).

# MORELO GRAND EMPIRE

**A vehicle that knows no compromise.**

The GRAND EMPIRE is at the pinnacle of our luxury motorhomes. With the unmistakable MORELO design line, it demonstrates in both the interior and exterior what first class travelling means: experiencing the perfect feeling of freedom without having to do without anything. Travelling to faraway places and still waking up at home - could there be anything better?





**MORELO  
GRAND  
EMPIRE**



# MORE OF EVERYTHING

**A MORELO eclipsing everything.** When our customers want even more luxury, even more space, even more performance and even more safety, we find a way to fulfil all their wishes. What's more, with the GRAND EMPIRE we exceed our own wildest expectations.

## Dimensions

Width: **2,55 m**

Length: **10,05 - 12,00 m**

Height: **3,84 m**

SLIDE-OUT WIDENS THE HABITATION  
SPACE BY UP TO 45 CM

REAL GLASS CLADDING FOR  
HARMONIOUS INTEGRATION  
OF THE WINDOWS

AIR SUSPENSION  
ON FRONT AND  
REAR AXLE

MORELO  
GRAND  
EMPIRE

LIGHT ALLOY WHEELS  
ALCOA DURA BRIGHT  
OPTIONAL

Highlight layout

GRAND EMPIRE 119 GSO

### Technical specifications

Chassis: Mercedes-Benz Actros 1840 / 1846 / 1853 / 2553 L

Emission class: EURO VI e

Engine: 10,7l / 12,8l

Power: 290 kW / 394 hp | 335 kW / 455 hp  
390 kW / 530 hp

Technically permissible max. weight: 18.000 kg / 26.000 kg

Choose from eighteen model  
options and customise your  
Grand Empire according to  
your preferences.

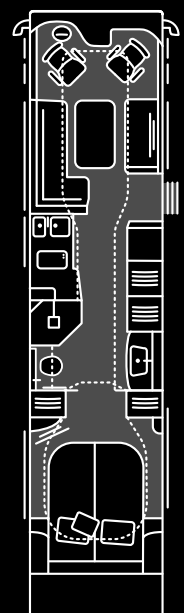
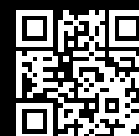

# COMFORT AT THE WHEEL

## The journey begins as soon as you take your seat.

The high-quality pilot seats with air suspension, lumbar support and adjustable armrests ensure a high level of seating comfort and support a healthy posture - even on long journeys. Thanks to seat heating and ventilation, there is always a perfect climate, regardless of the ambient temperature. This ensures that you arrive at your destination as relaxed as possible.



**Added safety:**  
the innovative  
MirrorCam  
system.

**Bird's eye view:**  
The Birdview camera set  
gives you eagle eyes.





MORELO  
GRAND  
EMPIRE



- + **Pilot seats** in ROYAL leather upholstery
- + **Multimedia cockpit**, interactive
- + **Digital camera system** MirrorCam
- + **Birdview camera set**
- + **Mercedes navigation system**, original
- + **Air conditioning** in the driver's cab

# SLIDE-OUT MAGIC

**What makes the GRAND EMPIRE so inviting?** Endless space. With the optional slide-out, you can extend the spacious living area and kitchen in your GRAND EMPIRE by up to 45 cm. Without cold bridges and at the touch of a button. In addition, a soothing massage awaits you on the luxury lounge, also at the touch of a button. The ergonomically shaped pilot seats can be swivelled and offer maximum seating comfort - ideal for long journeys.



**Real glass windows in the living area,**  
double-glazed and tinted.





**MORELO  
GRAND  
EMPIRE**



- + **Slide-Out** with up to 45 cm more width in the habitation area and kitchen, including enlarged kitchen worktop (depending on layout)
- + **Underfloor heating** in cockpit, living area and bathroom
- + **Two double-glazed panoramic skylights** in living area and bedroom
- + **Luxury lounge** with massage function and movable leg rest (depending on layout)
- + **Technically permissible max. weight up to 26 tonnes** for almost unlimited payload



# THE BEST MEALS ARE PREPARED AT HOME

**Blanched? Flambéed? Roasted?** Roast beef with jacket potatoes or Crema Catalana? The GRAND EMPIRE offers the perfect ingredients for every taste: From the high-quality BSH domestic oven with microwave function to the induction hob and the 172-litre BSH domestic refrigerator with freezer compartment, nothing is left to be desired. All in a powerful 230 volt design. So that everything feels like home.

- + **BSH domestic oven**  
with microwave function
- + **Induction hob**
- + **Single lever mixer tap** in chrome
- + **Drawers with soft pull-in**  
& cutlery insert





**Mineral worktop**  
with seamlessly integrated  
sink & leftover bowl  
for top hygiene.



**MORELO  
GRAND  
EMPIRE**



**Luxury dishwasher**  
as pull-out under the hob.



**BSH domestic refrigerator**  
172 litre refrigerator with 15 litre freezer  
compartment and soft-close doors.



# YOUR MOBILE BATHROOM

**Simply stop time.** Simply be yourself. In a MORELO GRAND EMPIRE, even such exclusive wishes come true. Look forward to an en suite bathroom of the absolute top class. Discover numerous amenities and comfort details. Be inspired by a place that harmonises body, mind and soul.

- + **Large wardrobe** with LED lightning
- + **Comfort shower** made of real glass with rain shower and hand shower
- + **Washbasin** with seamlessly moulded washbasin with push-open valve
- + **Ceramic toilet** with approx. 280 litre fixed tank



**The comfort shower** transforms the bathroom into a luxury oasis..

**MORELO  
GRAND  
EMPIRE**

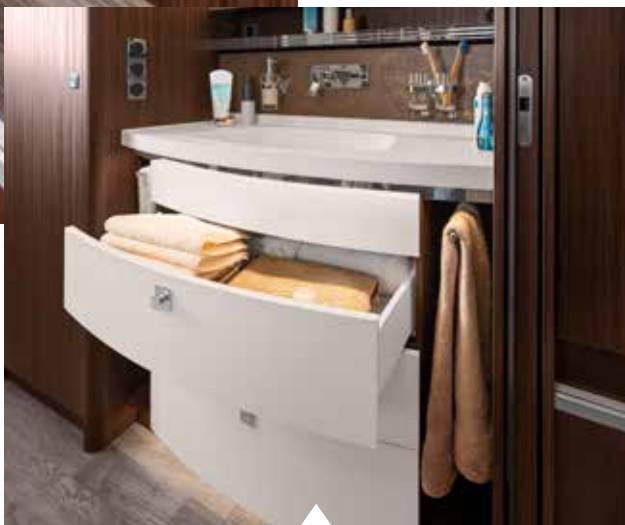

**Generous washbasin** for more elegance and space.



**Toilet** made from high-quality ceramic.

# BEAUTIFUL DREAMING IN THE GRAND EMPIRE

**Imagine falling asleep in the most beautiful places in the world in the cosiest bed in the world.** Sounds good? Feels even better! This is ensured by high-quality EvoPore multi-zone mattresses, an ergonomic Watergel top layer and a first class comfort slat base. Together they provide a turbo boost for your relaxation.



**Large wardrobe**  
with LED lighting





MORELO  
GRAND  
EMPIRE



- + **Spacious wall units**
- + **Window** with fly screen and pleated blackout blind
- + **Multi-zone EvoPore mattress**
- + **Adjustable headboard** on mattress
- + **Cleverly positioned sockets**

**BED OVERVIEW** / 124 - 125

# ROAD TRIP MOOD

Is there anything better than exploring the most remote bays and fishing villages at your holiday destination in a car that is as nimble as it is manoeuvrable? The MORELO GRAND EMPIRE fulfils this wish too. With a rear garage that, depending on the model and layout, can easily accommodate compact and sports cars up to 4.60 metres in length, you will always be flexible when you are on the road.

REFUELLING WITH SOLAR PANELS  
UP TO 1,680 WATTS

BIRDVIEW CAMERA FOR A  
UNIQUE ALL-ROUND VIEW





#### **Sports car platform**

With the GRAND EMPIRE 119, a sports car platform ensures maximum comfort when loading and unloading your piece of jewellery.

- + **Rear garage with electric tailgate** for cars and sports cars up to a length of 4.10 metres (depending on layout)
- + **Motorised cable winch** with emergency stop function
- + **Rear garage can also be used** for bicycles, scooters and motorbikes
- + **Passage (H x W in mm):** 1.570 x 2.100

**UP TO 390KW /  
530 hp**

**MORELO  
GRAND  
EMPIRE**



**Technical specifications**

Base vehicle
Cubic capacity starting at
Max. power (kW/HP) starting at
Length starting at
Width
Height
Interior standing height
Driving licence class
Double floor height
Fresh water / grey water tank capacity (ca.)
Black water tank capacity (ca.)
Car garage option
Price from

**LOFT ALKOVEN / LOFT PREMIUM ALKOVEN****IVECO Daily**

70 C 18

3,0 l

129 / 175

8,99 m

2,40 m

3,55 m

2,02 m

C1

460 mm

360 l / 250 l

250 l

x

209.650,00 €

**LOFT / LOFT PREMIUM****IVECO Daily**65 /  
70 C 18

3,0 l

129 / 175

7,99 m

2,40 m

3,49 m

2,02 m

C1

366 mm

300 l / 200 l

200 l

x

221.750,00 €

**LOFT LINER / LOFT PREMIUM LINER****IVECO Eurocargo**75 E 21 /  
100 E 22 / 120 E 28

4,5 l

152 / 207

7,99 m

2,40 / 2,45 m

3,55 / 3,71 m

2,02 m

C1 / C

420 mm / 480 mm

360 l / 250 l

250 l

o

272.150,00 €

**Standard equipment / option**

Fixed tank toilet
Underfloor heating
Air conditioning cab
Engine heat exchanger
LED reversing lights
Flush-mounted cab windows
Panoramic rooflight in the living area
Entrance with 2 drawers
TOP-Class entrance door
Premium bathroom
Dashboard with ambient lighting
Premium cockpit
Air-suspended seats
Air suspension
Front / rear axle
Automatic gearbox

■

o

■

o

■

x

o

x

x

x

x

x

o

x

x / ■

o

■

o

o

o

■

■

o

x

x

x

■

■

o

o

o / o

o

■

o

■

■

■

■

o

■

x

x

x

■

o

o

P

■



**PALACE**

**PALACE LINER**

**PALACE LINER  
S-WAY**

**EMPIRE LINER**

**GRAND EMPIRE**

**IVECO  
Daily**

**Mercedes-Benz  
Atego**

**Iveco S-Way**

**Mercedes-Benz  
Atego**

**Mercedes-Benz  
Actros**

70 C 18	1230 L / 1530 L	190 S34 / 190 S40	1230 L / 1530 L	1840 L / 1846 L / 1853 L / 2553 L
3,0 l	7,7 l	8,7 l	7,7 l	10,7 l
129 / 175	220 / 299	251 / 340   294 / 400	220 / 299	290 / 394
8,69 m	8,99 m	9,59 m	9,65 m	10,05 m
2,45 m	2,45 m	2,55 m	2,55 m	2,55 m
3,58 m	3,75 m	3,84 m	3,79 m	3,84 m
2,06 m	2,06 m	2,06 m	2,10 m	2,10 m
C1	C	C	C	C
420 mm	480 mm	480 mm	480 mm	480 mm
360 l / 250 l	360 l / 250 l	360 l / 250 l	410 l / 280 l	410 l / 280 l
250 l	250 l	250 l	280 l	280 l
○	○	○	○	○
282.250,00 €	393.200,00 €	433.500,00 €	473.850,00 €	599.900,00 €

■	■	■	■	■
■	■	■	■	■
■	■	■	■	■
■	■	■	■	■
■	■	■	■	■
■	■	■	■	■
■	■	■	■	■
■	■	■	■	■
■	■	■	■	■
■	■	■	■	■
■	■	■	■	■
■	■	■	■	■
■	■	■	■	■
■	■	■	■	■
■	■	■	■	■
■	■	■	■	■
■	■	■	■	■
■	■	■	■	■
■	■	■	■	■
■	■	■	■	■
○	×	×	×	×
○	○	○	■	■
○ / P	■	■	■	■
○	■	■	■	■

**MORELO  
TECHNO-  
LOGY**

**Prices in € (incl. 20 % VAT)**

■ Standard equipment    × Not available    ○ Special equipment    P See price list



NEXT  
LEVEL  
EXTERIOR



MORELO  
**TECHNO-  
LOGY**



**The front and rear remain true to the typical MORELO design language.** As the icing on the cake, we have integrated a full-length rear light. The curved windscreen enlarges the field of vision, reduces wind noise and cuts an elegant figure at the same time.

# LIGHT DESIGN

The **LED lighting concept** bears the unmistakable MORELO signature. This is where functionality meets stylish, automotive design. An eye-catcher, not just at night.



**LED headlights**, as standard. When turning, the LED fog light is activated and ensures perfect illumination.



### LED indicators

Better visibility and higher luminosity thanks to LED technology ensure greater safety on the road.



### LED combination rearlight

The rear light extends across the entire width of the vehicle. Inconspicuous is something else.



### LED braking light

Safety aspects stylishly packaged: when braking, the entire rear end appears illuminated in red.

**New and good:** the beautifully shaped windscreen scores points with its improved aerodynamics and field of vision. We are also impressed by its futuristic design.



**Handleless outer flaps (PALACE)** blend seamlessly and elegantly into the side walls. The flap is unlocked via a switch concealed in the rubber seal. Of course with central locking.

EXPERT ADVICE

[www.meier-caravaning.de](http://www.meier-caravaning.de)

## THE BEST BUILD ON US

We are MEIER and the best build on us - we stand for quality in the motorhome industry. At Fahrzeugbau MEIER, we lay the secure foundation so that you can set off on your next journey without any worries.

And if something is missing, our service partner MEIER Caravantechnik will be there to help and advise you.



MORELO  
TECHNO-  
LOGY

### OUR LOCATIONS

96152 Burghaslach  
90518 Altdorf



← learn more

# MEIER

Auf uns bauen die Besten

# MORELO CONNECT



**One for everything.** With MORELO CONNECT, you can control heating, lights, electrics, multimedia or fill levels centrally from one place. This leaves more time for the essentials.



### Digital central control

The central touch display above the door provides a convenient overview and control of all your systems.



### Control via navigation system

Are you currently in the cockpit?  
Then save yourself the trip to the door.

» OK Garmin!  
Switch off  
the bedroom  
light. «



### Control via app

Lying down becomes an art form, dim the lights or turn off the TV via your mobile phone.



### No more searching for the light switch in the dark -

thanks to these elegant glass switches with proximity sensor.

### Control via voice command

Lights, heating and multimedia follow your instructions - from anywhere in the vehicle.

# VICTRON ENERGY

**New standards in the LINER range from PALACE:** the entire power supply is adapted to high-performance energy systems from the renowned manufacturer Victron Energy and impresses with 24 V. A power supply so good that even your socket will be amazed.

## Blue and powerful as lightning

The direct current distribution system from Victron Energy ensures that the energy from your batteries is utilised efficiently. The system also scores points for its powerful performance, simplicity and safety.



MORELO  
TECHNO-  
LOGY



**The intelligent battery charger** from Victron is both powerful and robust, making it ideal for mobile use wherever you are travelling.



**All information about the power supply** Flexible communication centre with app access and detailed display of charging and discharging processes.

# SOUND SYSTEM

**Experience worlds of sound.** With the sound system, you can transform your MORELO into a concert hall on wheels for a sound experience you can even feel. Thanks to the intelligent connection to the ESX system, you benefit from smart solutions for control via mobile phone and tablet.

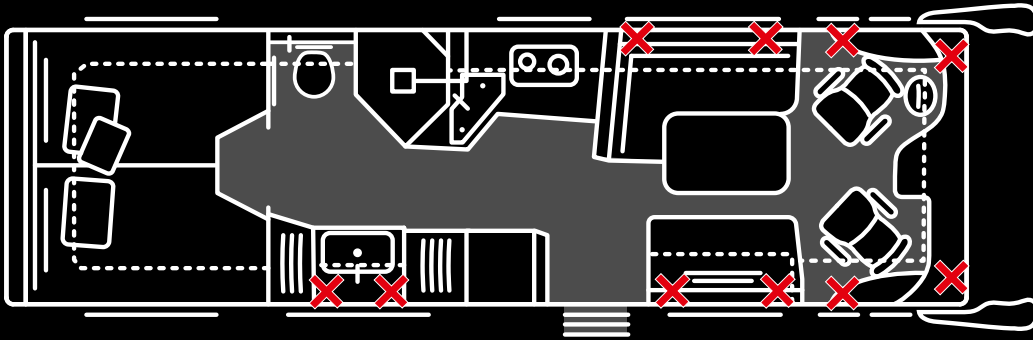

# NEW MATERIALS



**Sound system.** Enjoy your favourite music in outstanding sound quality anywhere in your motorhome.



**Honeycomb structure**  
Noticeable weight saving without sacrificing stability.



**Metal drawers (LOFT model range)**  
contribute to weight savings thanks to their lightweight construction and offer plenty of space and stability.



# PRO KITCHEN

## More power, 50% less energy consumption

Powerful household appliances from BOSCH & Siemens turn every journey into a culinary highlight. Enjoy relaxed cooking evenings as you know them from home. Unbelievable, but true: despite the high-quality appliances, you can save up to 50% energy compared to previous models.



### BSH domestic refrigerator.

Food feels well stored in the 172-litre refrigerator with vegetable compartment and 15-litre freezer compartment.



### Pull-out cabinet.

The perfect solution for tidiness and organisation without sacrificing space.



### BSH oven with microwave function

Conjuring up the perfect dinner while travelling? The oven with microwave function makes it possible.

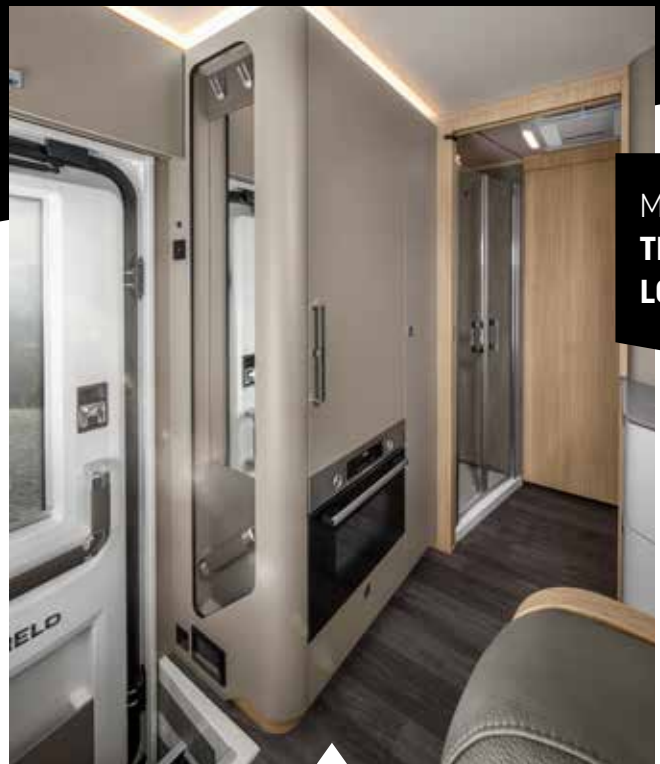

### LOFT fridge with coat rack and wardrobe

Thanks to the well thought-out design, all components come together to form an intelligent room concept.

MORELO  
TECHNO-  
LOGY

# SUPERIOR DRIVING EXPERIENCE



**Driving like on rails, only much more mobile and dynamic.** They are the supporting pillars of your unlimited MORELO travelling pleasure: IVECO or Mercedes Benz chassis stand for excellent quality, superior performance and state-of-the-art chassis technology. And because we not only want to protect ourselves, but also our fellow human beings, the underride guard at the front and rear ensures that no car gets under the wheels.





**Sturdy ladder frame**

The galvanised ladder frame provides a solid base.

**Hydraulic leveling system**

A lifting support system (optional) offers maximum comfort and is particularly useful for longer downtimes.



**GRP front module**

Developed together with Fahrzeugbau MEIER and already installed thousands of times in MORELO motorhomes.

**EXPERT ADVICE**

[www.iveco.com](http://www.iveco.com)

# SIMPLY GET AHEAD EVERYWHERE

Best combination: differential lock and Traction+

**IVECO  
CAMPER**

**MORELO  
TECHNO-  
LOGY**



The Daily HI-MATIC is the only chassis in its class with rear-wheel drive that combines the comfort and safety of a mechanical differential lock and Traction+.

The mechanical differential lock guarantees continued driving on difficult surfaces, as it transfers the full torque to the grip wheel. Traction+ is used as an additional function when travelling on routes with different road conditions, especially on winding roads, as - unlike the mechanical differential lock - it can remain activated even on slippery surfaces.

**With this combination, you are always safe and carefree when travelling.**

Your IVECO motorhome experts

**Cornering behaviour.**

A new dimension in driving behaviour: The optional wider front axle and offset wheels maximise stability and minimise lateral inclination.



**Travelling like on clouds -** the optional air suspension makes it possible.

**Telma retarder**

The wear-free optional eddy brake takes over up to 90 per cent of all braking processes. It effectively relieves the service brakes and minimises wear.

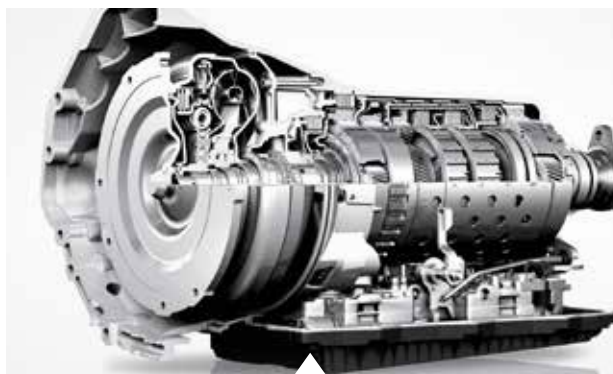

**ZF 8-speed torque converter transmission (IVECO Daily)**

Drive comfort at its best. This is what the new 8-speed automatic transmission from the transmission specialist ZF offers.



**Intelligent and clean: AdBlue**

with the separate flap for the AdBlue filler neck, filling is easier than ever.



**VB-Airsuspension "ActiveAir"**

This intelligent suspension and damping system (optional) adapts to road conditions and your loaded state in real time.



**Light alloy rims**

More elegance is not possible? We still have these graceful rims on offer.

**Trailer coupling**

Is the storage space on board not enough for you? With the trailer coupling, you benefit from even more payload.



**EXPERT ADVICE**

[www.vbairsuspension.de](http://www.vbairsuspension.de)



**MORELO  
TECHNO-  
LOGY**

**STABILITY  
& SAFETY**

VB-Airsuspension for optimum riding comfort, increased stability and more safety

Anyone who is on the road for hundreds of kilometres at a time naturally wants a stable and comfortable vehicle. That is why it is particularly important that the suspension system is in perfect technical condition.

With our next-generation air suspension system, your MORELO remains stable and manoeuvrable under all circumstances. A constant ride height is guaranteed. The vehicle becomes less sensitive to crosswinds and road irregularities, offers a more stable cornering position and reacts optimally during sudden evasive and braking manoeuvres, even with a heavy and uneven load.

# SAFE ON THE ROAD

**The best driving assistants you could wish for.** For first class driving safety, our models are equipped with numerous little helpers. This makes manoeuvring, turning and lane changes even safer. Everything in view. The feeling of maximum safety makes the driving experience even more special.

## Exterior bus-style rear-view mirrors

The extra-large exterior rear-view mirrors in an elegant design offer a clear view to the rear.



## Flush-fitting cockpit window

It can be opened continuously and protects against heat and cold thanks to insulating double glazing. The complete integration reduces wind noise and cold bridges.



## Bus windscreen wiper system

The quick and thorough cleaning of the entire windscreen area ensures a clearer view and breathtaking views on every journey.



## Clear view

With the generous panoramic windows, you always have everything in your surroundings in view and are therefore safe wherever you are travelling.



**Rear-view camera (optional)**

A reversing camera provides the perfect view to the rear so that you can not only see what is happening in front of you, but also behind you.

**MirrorCam (optional)**

With one camera for close range and one for the distance makes manoeuvring child's play.



**Safety assistance systems**

Make it easier for you to operate the vehicle and are a real bonus in reducing the risk of accidents.



**All-round view with Birdview**

Keep an eye on all situations with the Birdview camera set for a First Class all-round view.

**EXPERT ADVICE**

[www.zentrale-autoglas.de](http://www.zentrale-autoglas.de)



**ZENTRALE  
AUTOGLAS**  
Die Womo Profis

**MORELO  
TECHNO-  
LOGY**

Whether toughened or laminated safety glass: with over 33 years of experience in the field of glass, we can handle any stone chips, cracks and glass breakages for you.

**Mobile replacement of all windows in your motorhome - even at your holiday destination**

- + Stone chip repairs
- + Motorhome glass in OEM quality
- + Experienced, specialised fitters
- + Support in the event of an insurance claim
- + All services with warranty

**CRYSTAL CLEAR  
ADVANTAGES**

We provide a clear view

Small stone chip or large crack? Repair, refurbishment or replacement of the glass pane? When it comes to motorhome glazing, we do not have to be shy. We are also happy to support you with your MORELO directly on holiday: whether Trieste, Lake Tegernsee or Timmendorfer Strand.



# BETTER STOWAGE

## Accessible and well thought out

What good is the best organisation in a motorhome if you can't get to your luggage or controls in a jiffy? Exactly!



### Storage space miracle

Luxury also means plenty of space for leisure and hobbies. Plenty of storage space has therefore always been our standard.



### Electric bicycle lift

Top-placed: Bicycles can be stowed above the car in the garage without any muscle power.





### Rear garage

Thanks to the rear garage, you can take everything that is important to you on your journey and always have everything in view.



### Storage space

Conveniently accessible compartments for small and large items that make travelling more enjoyable.



### Central locking

Simply lean back, press the button and you can be sure that your belongings are well protected.

### Innovative storage compartment flaps

Perfectly integrated into the sides with access to the chassis, fuel tanks, batteries, waste water connections and technology (model-specific).



**MORELO  
TECHNO-  
LOGY**

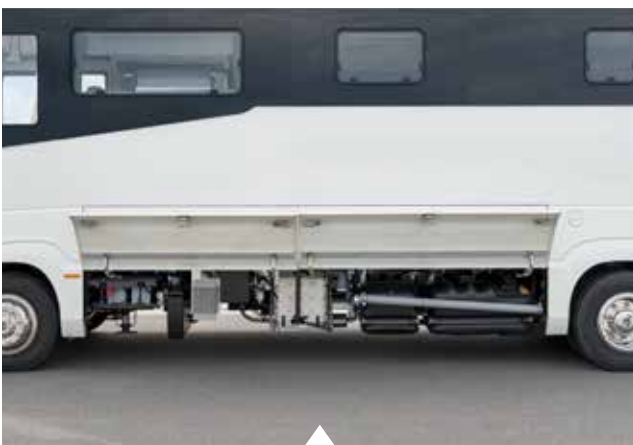

### Side skirts

In bus flap look (from EMPIRE LINER). With newly developed division of the underfloor and double floor.



### Bonnet

Easy access thanks to parallel opening and gas pressure dampers. The large radiator grille offers a dynamic, powerful look and protects against overheating.

# PREMIUM BODY

In a MORELO, you are surrounded by the best materials available in motorhome construction. The inner and outer walls made of a particularly corrosion-resistant aluminium alloy ensure stability and the hydrophobic XPS rigid foam provides sensational insulation. Naturally lightweight.

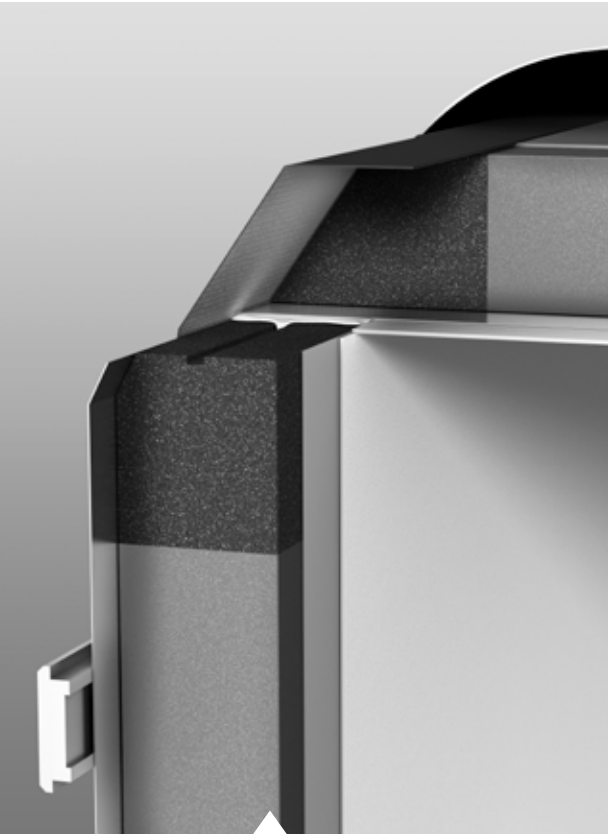

„HIGHLIGHT AT  
MORELO: 52 MM  
WALL THICKNESS  
FROM THE PALACE  
LINER S-WAY.“

*Reinhold*



### Premium roof structure

We build with care. And also think about intelligent water management for streak-free side walls.

### Premium living room floor

The high-quality PVC flooring with a wood look is easy to clean and absolutely water-resistant.

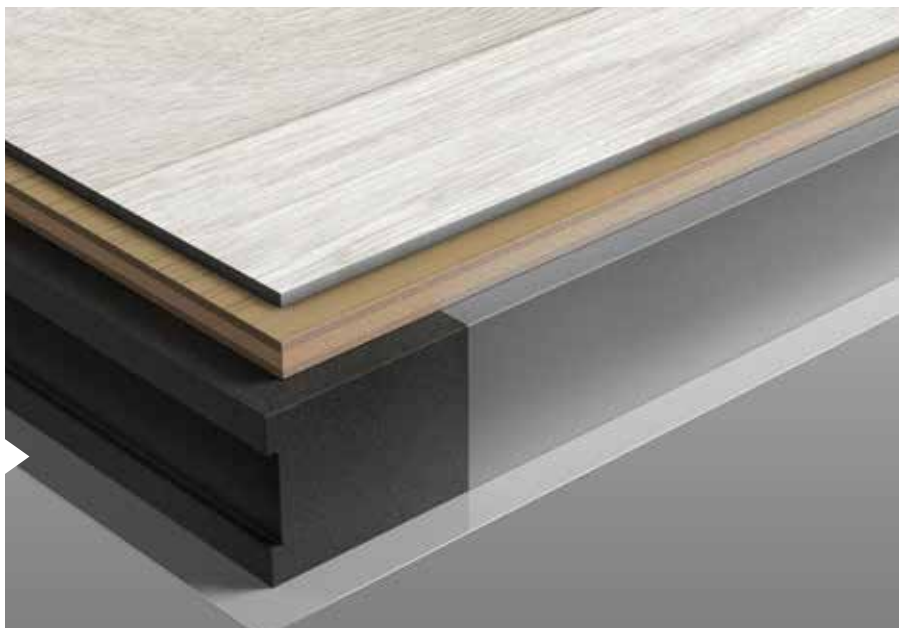

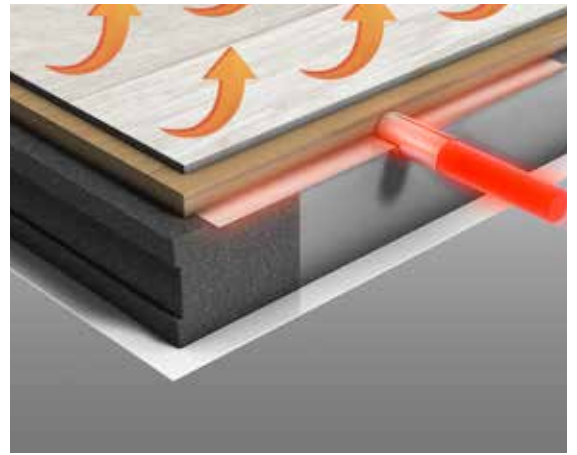

**Premium underbody**

Thanks to the stable GRP underside, you don't have to worry about moisture and corrosion.

**EXPERT ADVICE**

[www.ravagobuildingsolutions.com/industry](http://www.ravagobuildingsolutions.com/industry)

# QUALITY IS AT THE CORE

High-quality thermal insulation for your motorhome



**RAVATHERM XPS X**

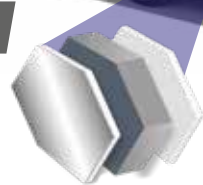

**GRP panels aluminium top layer**



**MORELO TECHNOLOGY**

For the best thermal insulation and durability of your motorhome or caravan, future-oriented manufacturers such as MORELO rely on the high-performance insulation materials from RAVAGO BUILDING SOLUTIONS. With their low weight and outstanding insulation performance, the core layer materials RAVATHERM XPS X PLUS RTM and RAVATHERM XPS X PLUS LB enable a high-quality wall structure - for maximum energy

efficiency, lower fuel consumption and a long service life for the motorhome.

**A further advantage:** thanks to their closed cell structure, the XPS insulation materials from RAVAGO BUILDING SOLUTIONS prevent mould growth, so you can enjoy your mobile home with peace of mind for longer.

# MORE POWER

**State-of-the-art technology.** With innovative power supply solutions for your motorhome, you can enjoy absolute freedom and operate all your devices completely independently, even off the beaten track in remote locations.



## Digital fuses

No more blown fuses - digital fuses make it possible!



## Batteries

Powerful batteries are crucial for a reliable power supply. If you want to be self-sufficient for even longer, you can even connect additional batteries in series.

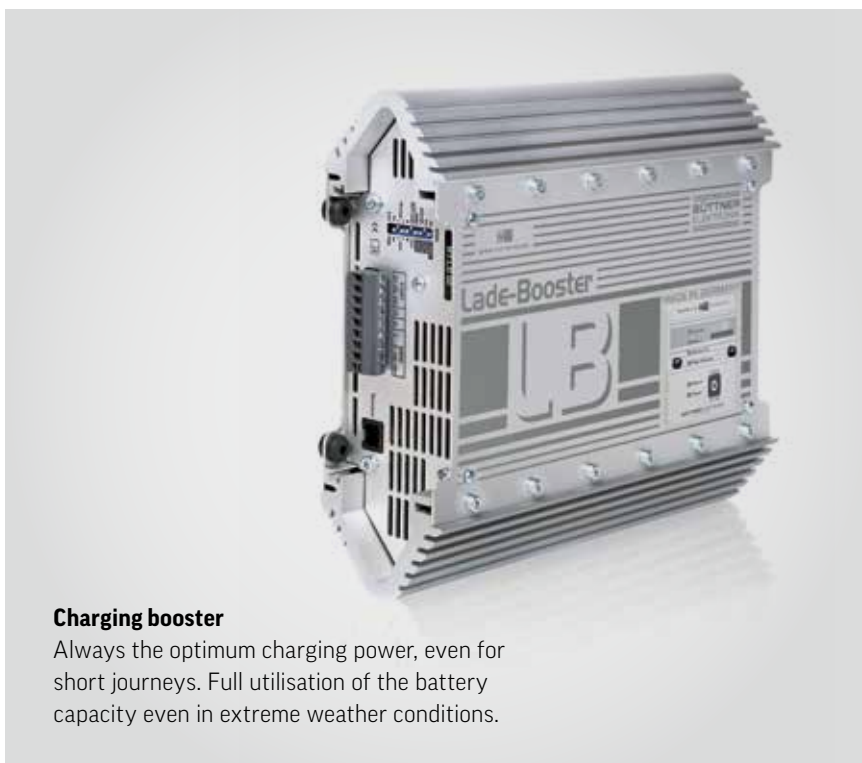

## Charging booster

Always the optimum charging power, even for short journeys. Full utilisation of the battery capacity even in extreme weather conditions.



## Inverter

A powerful energy centre ensures comfort on board. Even sensitive household appliances can be operated without any problems.



**This VDE-approved electrical control centre** keeps all supply, measuring and protection points clearly organised in one place. Just as it should be in domestic technology.



**Safety shutdown**

This increases the service life of the batteries enormously. This is because the safety cut-out ensures that they are disconnected from the system in good time before damage occurs due to deep discharge.

**EXPERT ADVICE**

[www.dometic.com](http://www.dometic.com)

# THE COOLEST EVER

## Dometic FreshJet FJX7 3500

This 3,500 W roof-mounted air conditioning system is one of the coolest we have ever built. The elegant roof unit with its exclusive LED light curve immediately catches the eye. Equipped with the latest variable speed inverter compressor and heat pump technology, it cools your vehicle faster, quieter and more efficiently than any other motorhome air conditioner on the market.



**MORE LO TECHNOLOGY**



With LED light curve



# SUPPLIED ALL ROUND

Whether you are on the beach, in the mountains or in the countryside - with energy from the sun or gas, your motorhome's power supply is guaranteed in all situations and you can travel independently of external power sources.



## Water tanks

Innovative light-tight dome tanks - all inlets and the tank ventilation are located in the dome, which enables complete filling.



## Hot water underfloor heating

Maximum efficiency thanks to hot water pipes elaborately integrated into the floor insulation.



## ALDE 3030 plus heater

Space and weight-saving hot water gas central heating with built-in heat exchanger, continuous hot water at approx. 4 l/min as a standard.



## Gas tank

This makes you even more independent: depending on the vehicle type, a gas tank of up to 150 litres (= approx. 55 kg) is possible.



## Electric waste water drains (optional)

We install household-quality pipes so that you can get rid of waste water quickly and easily.



**Simply fill up with sun:**  
each module has an  
output of 140 W.

**Solar**  
With the solar computer,  
you can keep an eye  
on the function of your  
solar system and are  
always informed about  
the charge status.



**Gas bottle**  
The GRP box is fully insulated,  
waterproof and offers storage space  
for two 11-kilogram gas cylinders.

**EXPERT ADVICE**

[www.dometic.com](http://www.dometic.com)

# PLENTY OF POWER IN YOUR MORELO

Thanks to solar power  
and battery charger

With this combination of high-performance solar module and high-performance inverter, you are equipped for all eventualities on your camping holiday. Thanks to the Multicell technology, the BLACK LINE solar system from Dometic delivers twice as much power per area as conventional systems - a clear advantage in unfavourable light conditions and partial shade. The Dometic Büttner MT ICC3000SI-N is recommended as an equal partner. The compact combi device combines a 3,000 W sine wave inverter with a 120 A automatic charger. A powerful charge controller from the new SC series from Dometic ensures perfect interaction with the solar system.



**MORELO  
TECHNO-  
LOGY**



**BÜTTNER | ↗ DOMETIC**



„OUR HEATING SYSTEM IS WELL THOUGHT OUT FROM A TO Z SO THAT YOU CAN ENJOY COSY WARMTH EVEN ON COLD DAYS.“

*Reinhold K.*

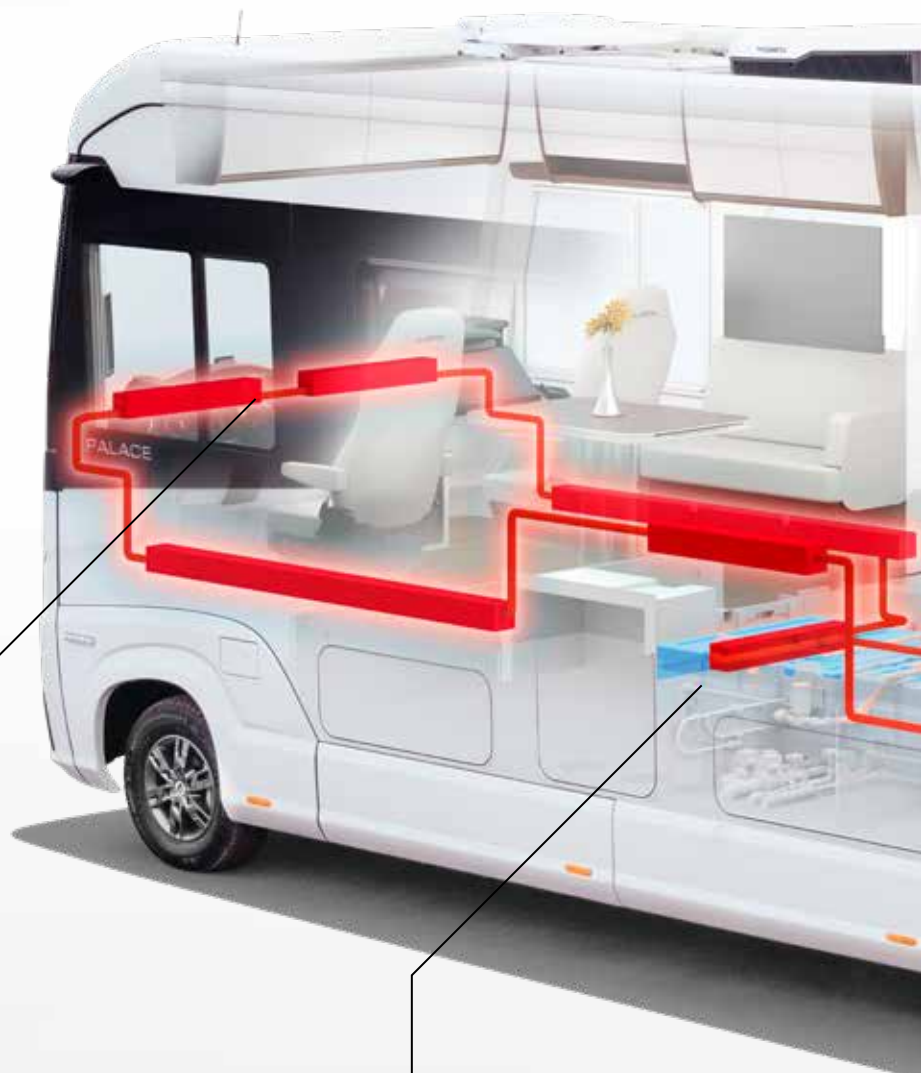

# HOT AIR

## WINDSCREEN RADIATOR

The radiators in front of the windscreen reduce the penetration of cold air.

- + Acts like a heat curtain
- + Optimised indoor climate
- + Clear view of the road

## HEATING CONCEPT

Various radiators do their job to create the typical MORELO feel-good ambience.

- + Hot water underfloor heating
- + Towel dryer (depending on model)
- + Bedroom and garage can be controlled separately





MORELO  
TECHNO-  
LOGY

### HEATED DOUBLE FLOOR

Optimum insulation and ideally positioned convectors protect tanks and pipes from frost.

- + Water tanks are protected from frost
- + Prevention of condensation
- + Even heat distribution in the vehicle

### HOT WATER CENTRAL HEATING

Do without? Not really our thing. Also applies to hot showers in the cold winter.

- + Gas operation 5.8 kW heat output
- + Electric operation up to 3 kW heat output
- + Continuous hot water at approx. 4 l/min



„THE EFFICIENT USE OF SPACE MEANS YOU CAN LIVE LIKE AT HOME WHEN TRAVELLING WITHOUT ANY COMPROMISES.“

*Robert Cingis*



# SENSE OF SPACE

## INDEPENDENT DASHBOARD

The independent dashboard is optimally adapted to the interior width of the motorhome and the needs of the driver and front passenger.

- + Perfect driver's seating position
- + 20 cm wider passage to the front
- + Cosy ambience

## RAISED DRIVER'S CAB

The high-strength steel construction forms a level living area floor with the double floor, the cockpit is integrated into the living area.

- + Perfect overview thanks to higher driving position
- + Driver's seat above the impact area of a car
- + Underride guard according to the latest standard



MORELO  
TECHNO-  
LOGY

### SPACE MIRACLE

Living room windows with internal pleated blinds and specially installed radiators offer unrivalled width.

- + Measurably more spacious than competitors
- + Bathroom can also be used comfortably by two people
- + Tempered glass living room windows (optional)

### VOLUMINOUS STORAGE COMPARTMENTS

All MORELO motorhomes impress with their exceptional storage space in the double floor and large scooter or car garages.

- + Cellar storage height from 366 to 480 mm
- + Heatable storage compartments and rear garage
- + Car garages for Smart to AMG GT



„THE SMART LIVING CONCEPT IS TAILORED TO YOUR NEEDS AND COMBINES LUXURY AND FUNCTIONALITY - FOR A FIRST CLASS FEELING AT HOME.“

*J. Hübner*



# HABITATION CONCEPT

## VARIABLE LIVING AREAS

MORELO First Class motorhomes stand for spacious living areas with ergonomically comfortable upholstery.

- + Lounge seating group or bar version
- + Upholstery in textile or leather
- + Tested 3-point seat belt system

## CULINARY DELIGHTS GUARANTEED

Gourmets rely on our cleverly designed and high-quality MORELO kitchens.

- + Extra deep kitchen cabinets and pull-out drawers
- + Kitchen worktop with double sink
- + High-quality BOSCH & Siemens household appliances



MORELO  
TECHNO-  
LOGY

### WELLNESS ON THE GO

Generously dimensioned, luxurious bathrooms, ample water supply and fixed tank toilet ensure comfort without compromises.

- + Large-volume water tanks
- + Fixed tank toilet
- + Household-quality shower

### SLEEP LIKE GOD IN FRANCE

Cosy beds, excellent spring suspension with ventilation and perfectly fitting multi-zone comfort mattresses - sleep like at home.

- + 5-zone comfort cold foam mattresses
- + Point-elastic comfort slat base
- + TV in the bedroom (optional)

# FIRST CLASS EXTERIOR

**Not only the overall impression**, but also the attention to detail characterise a First Class motorhome. With their functionality, all elements in the exterior contribute to providing you with a comfortable travelling adventure while cutting a fine figure on all roads with their unmistakable design.



## Extra-wide entrance door

Standard with MORELO: plenty of space when entering and exiting the vehicle. The door closes securely and quietly.

## Entrance portal

Electrically folding entrance steps, with two steps (three steps from 12 tonnes). The steps are very stable and provide a secure footing.

## Electronic combination lock

(from PALACE) for assigning your individual number combination for more security.



**Glass panelling and real glass windows** (standard for EMPIRE model range, optional for PALACE) not only score points in terms of improved visibility and greater safety, but also set accents in terms of modern design and noise insulation.



## Slide-out

For more space: the slide-out in the GRAND EMPIRE increases the width of the living area and kitchen by up to 45 cm.



**Awning integrated into the roof profile**

The optional awning is inconspicuously integrated into the roof profile and can be fitted as a single or even double awning on both sides of the vehicle.

**Satellite dish**  
The dish aligns itself fully automatically and offers a large reception area.



**Yes, look at that!**

The logo in the radiator grille shows where FIRST CLASS is at home.

**EXPERT ADVICE**

[www.ten-haaft.com](http://www.ten-haaft.com)



# FIRST CLASS ENTERTAINMENT

**MORELO TECHNOLOGY**

Now even more comfortable!

Experience even more first class moments when travelling with the award-winning Oyster® Premium products from ten Haaft. Enjoy together with us even more beautiful and brilliant home cinema with the award-winning Oyster® satellite system. For an even better viewing experience, we have the new Oyster® Smart TV in 27, 32" or 39" with VIDAA operating system and many other great features for you.

Our tip: With the VIDAA app, you can enjoy even faster and easier operation. Use it on your phone or tablet and take advantage of the app's additional benefits.

**Oyster®**  
by ten Haaft GmbH

# FIRST CLASS INTERIOR

**You will find the highest level of comfort wherever you look.** All seating options are made from high-quality materials and provide the comfort of a wellness holiday. The generous amount of space always ensures sufficient legroom and freedom of movement.



## Removable leather steering wheel

Feels good, looks good and ensures maximum freedom of movement (optional).

## Luxury cab seats

Relaxation made easy: not only heated, but fully air-conditioned on request.



## Ergonomic seat upholstery

Fans of comfortable seating swear by these two layers of cold foam of varying firmness.



## To me or to you?

This table can be moved and extended both lengthways and crossways.





**Bar seating group with cantilever table**

Get rid of the table leg for more legroom. Up to five belt seats are possible with the bar seating group.



**Roof ventilator**

Optimum ventilation always ensures fresh air in the living area.



**Integrated drawers**

Utilising storage space without moving upholstery - thanks to drawers in the lounge seating bench.

**Hidden eye-catcher:**

27-, 32- or 39-inch smart TV depending on model and preference, can be lowered electrically.



**MORELO  
TECHNO-  
LOGY**



**Blackout pleated blind**

can be freely positioned from above or below and serves as sun or privacy protection.

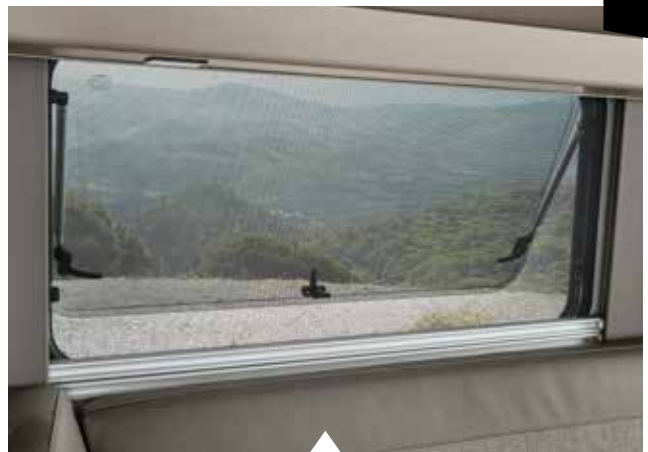

**Flyscreen**

Because uninvited guests must stay outside. Standard for all windows, skylights and the entrance door.

# LIVING ROOM

**Space in all options.** The standard lounge is equipped with ergonomic seat upholstery, a pull-out table and glass cabinet with LED lighting. Many other layouts offer a wide range of customisation options. We are sure that you will find your perfect MORELO layout.

## SEATING GROUP

**In all LOFT, LOFT PREMIUM and PALACE models,** the angled seating group, long bench and "bar" can be individually combined.

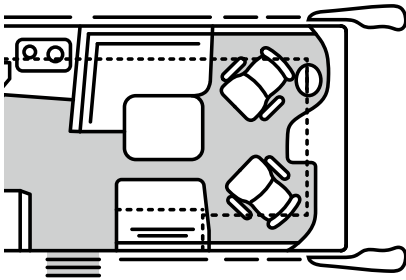

### Standard

The open seating group forms an elegant visual axis with the directly connected kitchen.

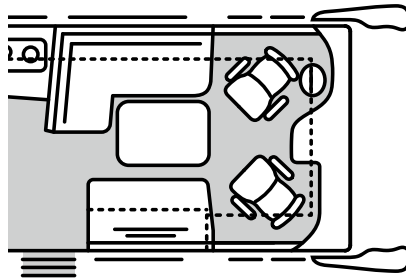

### Long bench

The extended bench creates more space and storage - in all "B" layouts.

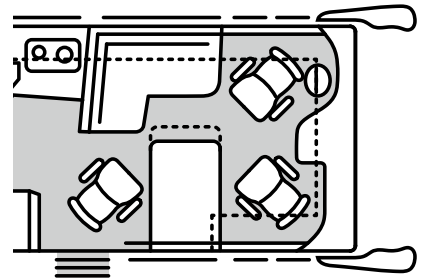

### Bar living room (optional)

Do you need five seats? With the bar living room option, there is a fifth seat in the seatbelt.

## LOUNGE

**EMPIRE LINER & GRAND EMPIRE models** give you the choice between various comfortable habitation layouts.

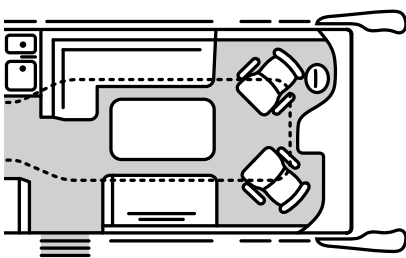

### Standard

A large L-shaped couch, the freely movable table and a generous couch offer plenty of space.

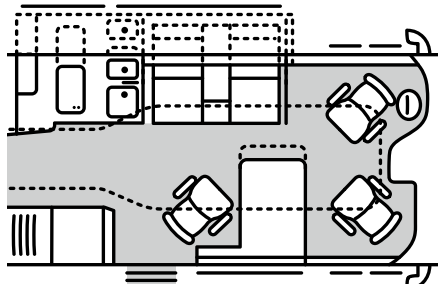

### Slide-out GRAND EMPIRE

A cantilevered bar table and third pilot seat provide plenty of space. The relax seats are included here.

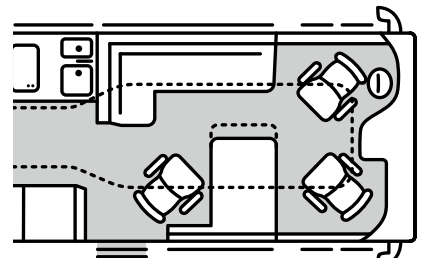

### Bar living room

The bar living room combines the L-shaped couch with a third pilot's seat and a cantilever table.

# BATH-ROOM

**Individual oasis of well-being.** Different customer wishes require different bathroom options. MORELO therefore offers different bathrooms depending on the vehicle, from compact to spacious and from the PALACE upwards, even with an optional separate toilet room.

## STUDIO

**Standard in all LOFT models.** The room concept with four mirror elements makes the bathroom appear very spacious.

Toilet and washbasin on the driver's side; real glass shower with two individual swing doors on the passenger side.

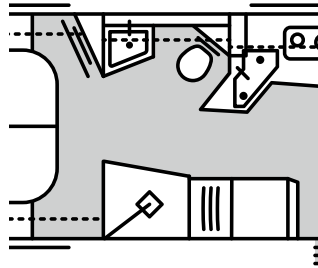

## ROOM

**Standard in all LOFT PREMIUM models.** Thanks to the intelligent design and clever nesting of the kitchen and shower, unimagined space is created.

Toilet and real glass shower on the driver's side; washbasin and mirror cabinet on the passenger side.

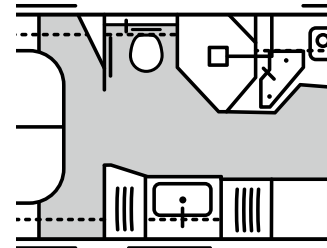

## PREMIUM

**Standard in the PALACE, EMPIRE LINER and GRAND EMPIRE** are new dimensions of generous equipment, whether for the shower or washbasin.

Toilet and real glass shower on the driver's side, large washbasin with large mirror cabinet on the passenger side.

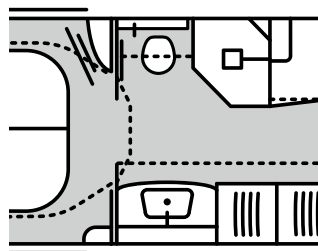

## LUXURY

**Optional for PALACE, EMPIRE LINER and GRAND EMPIRE:** extra privacy guaranteed by the separately lockable toilet area.

Washbasin and real glass shower on the driver's side, separate toilet with a window on the passenger side.

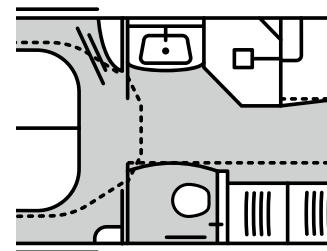

# BED-ROOM



**Three bed options are available for the bedroom furnishings.** Cold foam mattresses with point-elastic spring bases (depending on the model) offer optimum body support and ensure an optimal sleeping climate thanks to integrated air channels.

## TWIN BED (L)

**Dream space.** The twin bed offers you maximum space and is available as a double bed.

**It could not be any wider:** the entire width is utilised and offers more than enough space to stretch out and unwind.

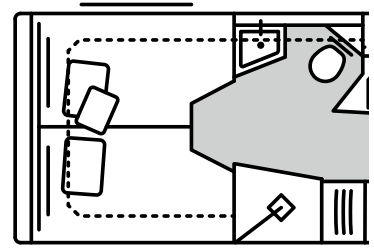

## QUEEN BED (M)

**Hop in please!** The queen bed is accessible from both sides, leaving room for two additional wardrobes.

**Simply climb into your bed** without disturbing your partner. There is plenty of storage space on top.

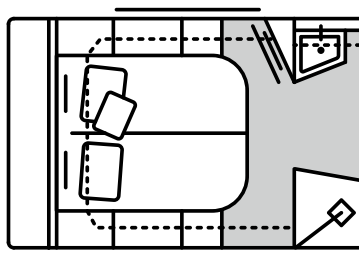

## FRENCH BED (F)

**Bonne nuit.** The F-layout means a so-called French bed available in all LOFT & LOFT PREMIUM models with an additional wardrobe in the sleeping area.

**Utilising the vehicle length efficiently** and not giving away any space to the rear without compromising on comfort.

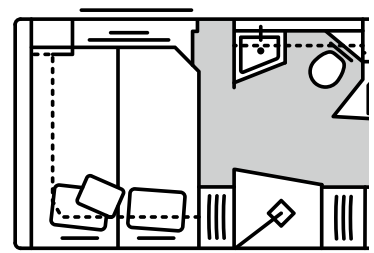

# OPTIONS

**Nowhere else does individuality play such an important role as in the perfect bed.** That is why we are happy to customise your bedroom to your individual sleeping requirements. Whether with a smart drop-down bed solution or an extra-wide king-size bed - we ensure that you have a restful night.

## DROP-DOWN BED

**Buttons with brains.** At the touch of a button, the drop-down bed transforms your motorhome into a cosy sleeping oasis and back into a comfortable living space.

**The space** between the lying surface and the ceiling is extremely generous and allows you to sit on the edge of the bed.

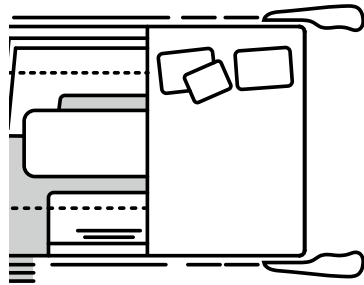

## LYING AREA FOR M-BED

**King-size bed.** The cosy lying area is a good option for those who like it a little cosier. There are also two wardrobes.

**More space to lie down,** more space to stow away - this bed option offers you both.

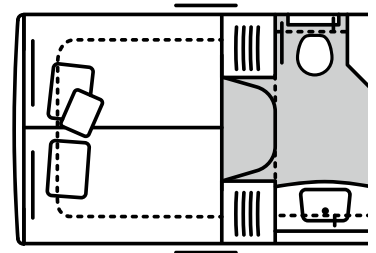

## FULLY EXTENDED LYING AREA FOR L-BED

**For those who sleep better.** On request, we can turn your L-bed into a large comfort zone that extends across the entire width of the vehicle.

**The non-plus-ultra** in terms of length and width. Ideal for both tall people and short people who love lots of space.

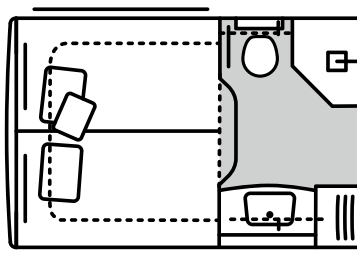

# HABITATION STYLES

**Unlimited combination possibilities.**

Design your motorhome to suit your personal taste! We will be happy to help and advise you and show you the most tasteful combinations of surfaces, upholstery and decorative colours.

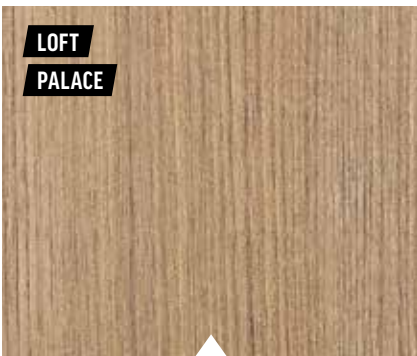

**LOFT**  
**PALACE**

**Furniture wood colour Balance**

Modern and timeless design for a pleasant and relaxing atmosphere.

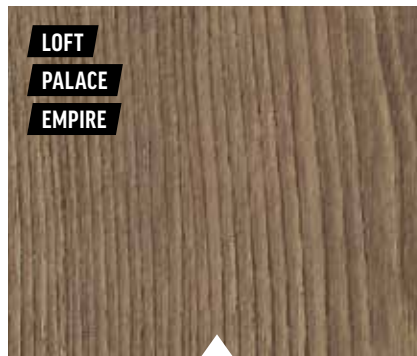

**LOFT**  
**PALACE**  
**EMPIRE**

**Furniture wood colour Life**

Visual calm thanks to versatility and excellent combinability.



**PALACE**  
**EMPIRE**

**Furniture wood colour Trend**

The noble and elegant wood colour adds character and warmth to the room.

## INTERIOR SURFACES

Light or dark? Or rather "Balance, Life " or " Trend"? The choice is yours. You can also flexibly select the matching furniture hatches.



**LOFT model range**

Balanced colour tones and a pleasant feel for cosiness.

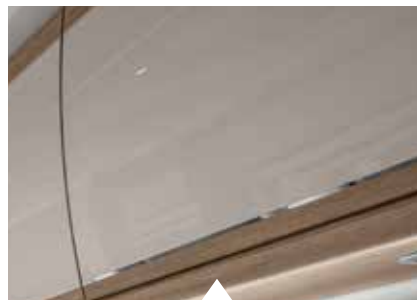

**PALACE model range**

Slightly shiny and high-quality materials for an elegant ambience.

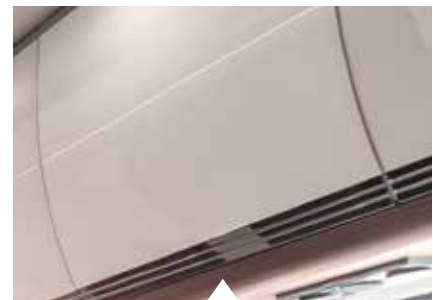

**EMPIRE model range**

Highly reflective wall unit surfaces combine style and elegance.

## UPHOLSTERY OPTIONS

The possibilities for the upholstery design are so numerous that even your sofa at home would turn green with envy. But don't worry; we will be happy to advise you.



### Leather

MORELO uses soft yet strong cowhide leather for the optional leather upholstery.



### Leather-textile combination

combines two contrasting material types to create a modern surface look.



## LIVING-ROOM TABLE

Lacquered real wood frames and hard-wearing, scratch-resistant laminate surfaces offer the highest quality.

The living room table for LOFT and LOFT PREMIUM is available in three different decors.



Slate



Marble



Mocha

The living room table from the PALACE is available in four different decors.



Viva



Lava



Stone



Quarz

## KITCHEN WORKTOPS

The seamlessly integrated sink and leftover sink is functional and very easy to clean thanks to its seamless and edgeless shape.



### Worktops

High-quality materials for worktops. We will be happy to advise you on many other designs.

## LIVING ROOM FLOORS

The surfaces of the floor coverings are easy to clean and extremely hard-wearing and long-lasting.



### Cappuccino

light and inviting, this floor is at its best when combined with a dark furniture colour.



### Dark grey

discreet and versatile, this floor works best in combination with light furniture colours.



**Carpet Velours**  
Grey-brown

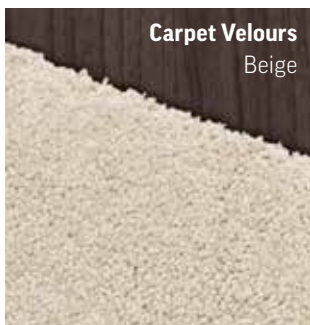

**Carpet Velours**  
Beige

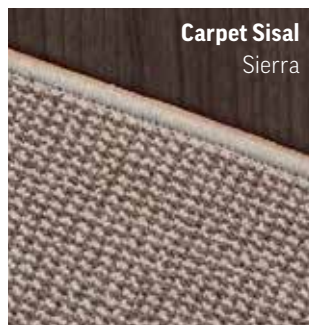

**Carpet Sisal**  
Sierra

## CARPETS VELOURS OR SISAL

The optional carpet variants in sisal and velours quality give the living room a pleasant atmosphere.



## SELECTED CURTAIN FABRICS

Your MORELO will be as individual as you want it to be. That is why you can of course choose your favourite from several fabric designs.

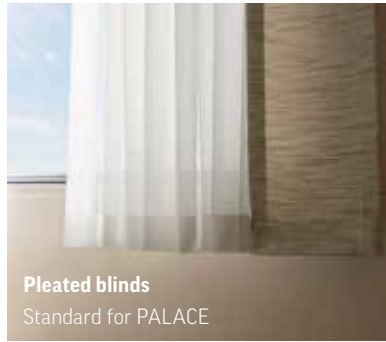

**Pleated blinds**  
Standard for PALACE

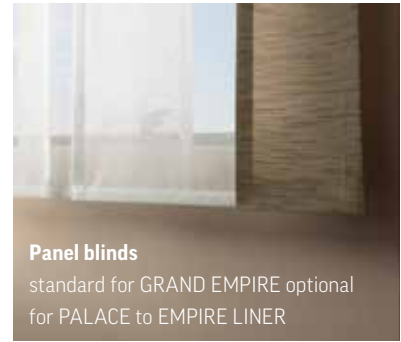

**Panel blinds**  
standard for GRAND EMPIRE optional for PALACE to EMPIRE LINER

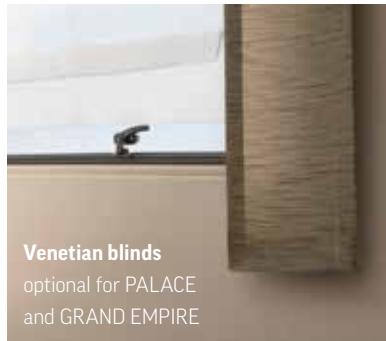

**Venetian blinds**  
optional for PALACE and GRAND EMPIRE

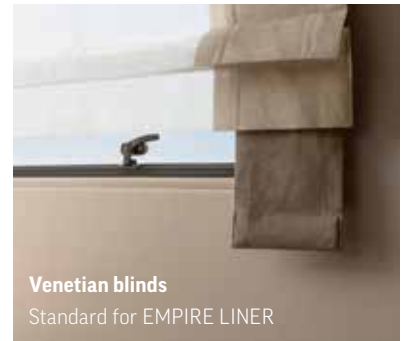

**Venetian blinds**  
Standard for EMPIRE LINER



**THE INTERIOR OF A MORELO MOTORHOME IMPRESSES WITH ITS LUXURIOUS FURNISHINGS, HIGH-QUALITY MATERIALS AND SOPHISTICATED DESIGN**



## HIGH QUALITY CEILING COVERING

The innovative, textile ceiling and side wall covering ensures a pleasant living ambience and has sound-absorbing properties.

# WELCOME HOME

We want our customers to feel  
this as often as possible

## FAMILIAR

- + honest
- + down-to-earth
- + optimistic



## DYNAMIC

- + experienced
- + motivated
- + hardworking

## FIRST CLASS

- + reliable
- + authentic
- + committed

This is what characterises us.  
This overall picture describes  
what makes us unique. We want  
everything we do to do this justice.

# OUR PASSION

A MORELO stands for travelling pleasure at a first class level. For freedom and adventure with maximum comfort. For creating a feeling like being at home on four wheels. Made in Germany.

Anyone who knows us is aware that these are not just empty brand messages - this is our philosophy in action. Of course, talent and drive are essential prerequisites for building good motorhomes. But it is this unwavering passion, the pure desire to travel and enjoy a cosy stay on the road, which is in every person and every MORELO

motorhome, that creates something outstanding. We were already convinced of this when we drove the first prototype to the Caravan Salon premiere in 2010 with glowing cheeks. And we still are today - as the leading manufacturer of luxury motorhomes in Europe. **Thank you for joining us on this incredible journey.**





# FOURTEEN MOVING YEARS

**78** / PRIZES & AWARDS

**133.000** / m<sup>2</sup> FACTORY AREA

**540** / FIRST CLASS EMPLOYEES

**32.500** / TONS OF MATERIAL PROCESSED



**69** / MIO. EURO  
INVESTED

**4.640** / MOTORHOMES  
PRODUCED

**10** / MORELO MODEL  
RANGES

**5.500** / m<sup>2</sup>  
SERVICE CENTRE

# THE PEOPLE BEHIND THE BRAND



**Extra class needs heart, brain and craftsmanship.** In our Upper Franconian manufactory, development engineers and foil specialists, designers and mechatronics engineers, carpenters and many other hands give their best every day. Because excellence is our standard. We are very proud of our professional team. And of every single MORELO that leaves our factory.





**MORELO Reisemobile GmbH · Helmut-Reimann-Straße 2 · D-96132 Schlüsselfeld · Fon: +49 (0) 95 52 - 9296 00 · [www.morelo-reisemobile.de](http://www.morelo-reisemobile.de)**

Subject to corrections and technical changes. Note that some of the images in this catalogue show alternative designs or special equipment that incur extra costs. Deviations in colour are possible from printing. Reproduction in whole or part permitted only with the express permission of MORELO Reisemobile GmbH.