



RANGE 2011

IN THE PAST THE STORY OF THE FUTURE IS WRITTEN



60 YEARS OF DIALOGUE WITH THE FUTURE



Elnagh has celebrated its 60th birthday, an exultation of innovation in everything from technology to engineering, because the world moves forward, driven by Elnagh.

With one idea after another, Elnagh rounded the half-century buoy and now sails onward toward its hundredth year, carried along by the same enthusiasm that has made it so famous throughout these years. With a company as vital and spirited as Elnagh, every product is a success well loved by its customers and admired by critics. Suffice it to think of all the articles written in Elnagh's time-honored magazine, *Andiamo*.

Elnagh is more than a brand, Elnagh is a way of thinking that is always oriented toward tomorrow, ahead of its time but with a deep appreciation for its history.

Elnagh has decided to celebrate its anniversary by unveiling the new *Magnum*, a historical motorhome with a glorious past.

One thing is certain. With Elnagh you always move forward: tomorrow's discoveries are already in the workshop.





IN THE PAST THE STORY OF THE FUTURE IS WRITTEN



For 60 years, Elnagh has been creating, innovating and redesigning the concept of movement. From the flexible fork for motor driven bicycles to the motorhome, Elnagh expresses all its exquisitely Milanese ingenuity with the same creativity that characterizes fabrics from the Eden of fashion.

With one of the largest fleets circulating in Europe, Elnagh is the best known brand on the road and in campgrounds. Elaborate words are no longer needed to describe it because each of its products contains everything that has always distinguished the brand and its history: inventiveness, determination and engineering.

Thanks to its youthful inventors, skilled artisans, project technicians and designers, Elnagh is a company one step ahead of the game, offering elegant and functional solutions with an attention to detail that only solid experience can offer.

Marco Polo was familiar with precious fabrics, Michelangelo was a master artist, Christopher Columbus studied sea routes. Elnagh creates campers. An Elnagh camper is a jewel of precision and comfort.



BARON

BARON RANGE PLUS

Baron. Elnagh welcomes you into the family.

If you have never climbed into an Elnagh camper, Baron is the one for you. Baron is the perfect camper for those who want to grab their bags and set off without any limitations. Baron is warm if you want to travel northwards and cool if you prefer to head south. It is comfortable in the winter and a pleasant refuge from the heat in the summer. Elnagh has already thought of everything, you just have to turn the key.



Control panel on entry door with master switch.

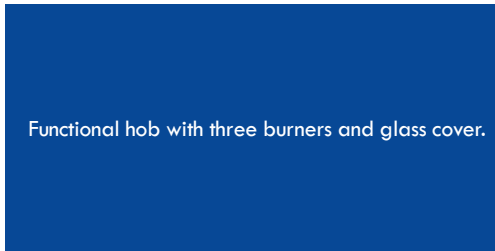

Functional hob with three burners and glass cover.



Wider track for secure road-holding and improved cornering stability.

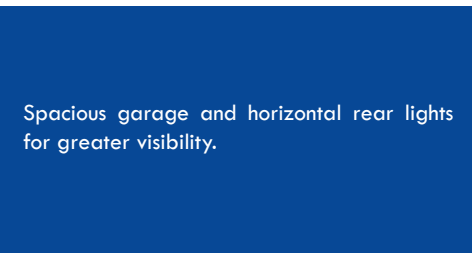

Spacious garage and horizontal rear lights for greater visibility.

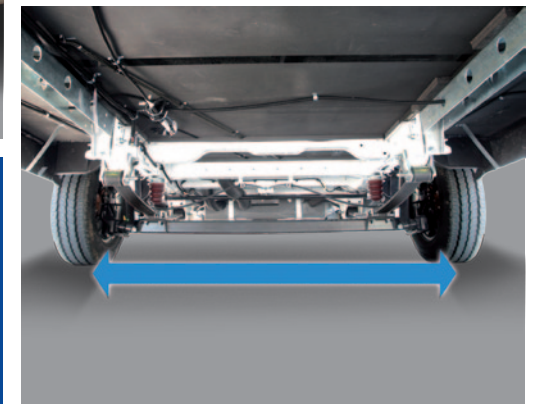

BARON RANGE COACHBUILT MODELS



BARON 37



BARON 46



BARON 47D

BARON RANGE LOW PROFILE MODELS



BARON 420L



BARON 580L

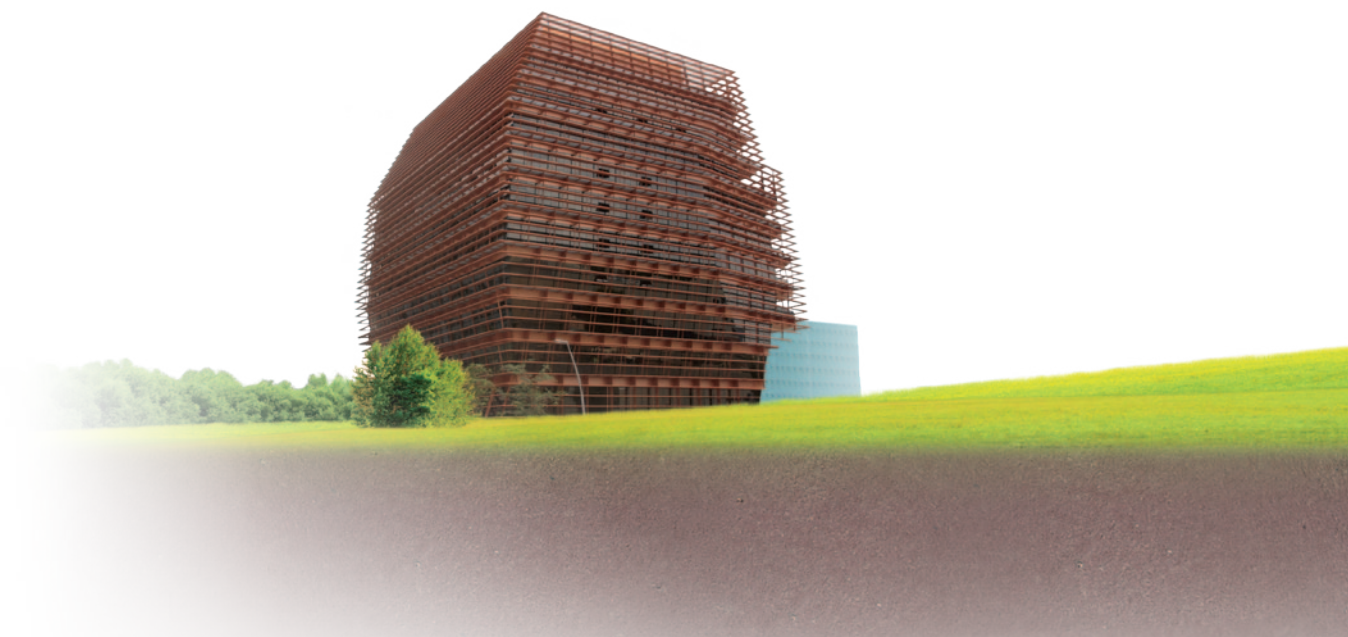

elnagh

BARON 47D



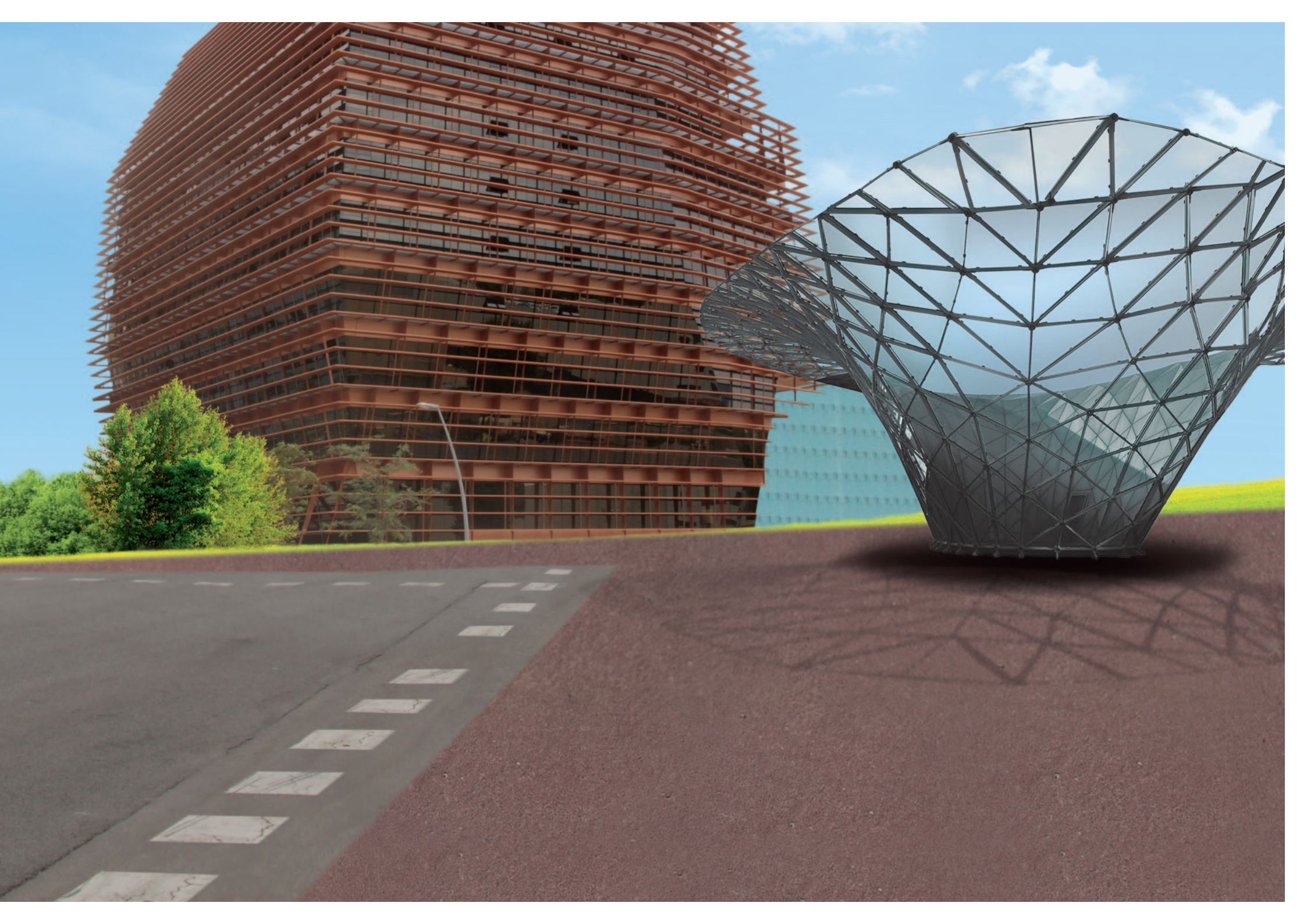

BARON 47D





elnagh

BARON 580L





BARON 580L





DUKE

DUKE RANGE PLUS

Duke. Creativity on the go.

Every vacation is a perfectly balanced mix of relaxation, adventure and wellbeing. Duke offers it to you all in one: the freedom of traveling easy on a journey of discovery of new and intriguing places, the pleasure of sleeping between two pillows before returning home satisfied and regenerated.



New aerodynamic design of the cab-over window.

Seitz living compartment window with polyurethane frames.



Wider track for secure road-holding and improved cornering stability.

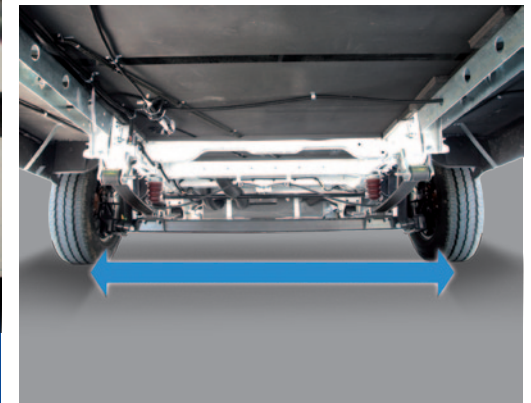

DUKE RANGE COACHBUILT MODELS



DUKE 46



DUKE 55

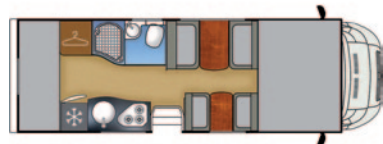

DUKE 57D





elnagh

DUKE 46



DUKE 46













DUKE 55





T-LOFT

T-LOFT RANGE PLUS

The natural habitat of those who seek doubly innovative non conventional spaces.
T – Loft is the pleasure of traveling without limits in perfect Elnagh style

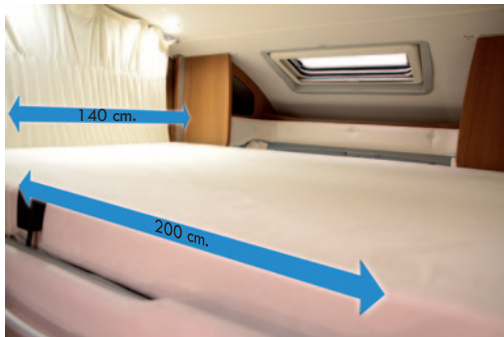

Tilt bed 140x200cm.

Seitz living compartment window with polyurethane frames.



150 lt. Refrigerator

Wider track for secure road-holding and improved cornering stability.

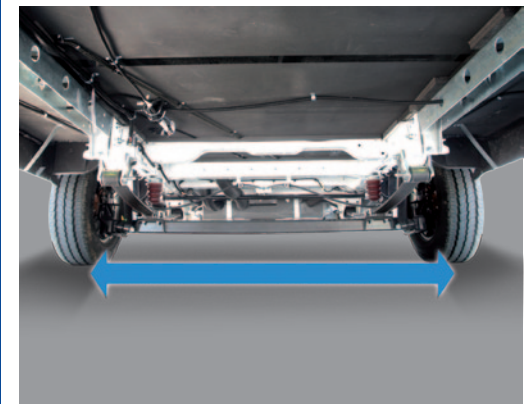

T-LOFT RANGE LOW PROFILE MODELS

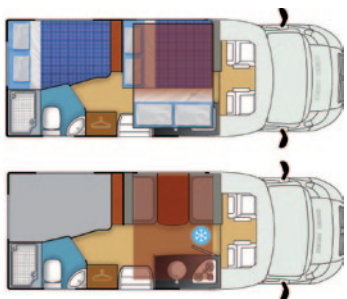

T-LOFT 31

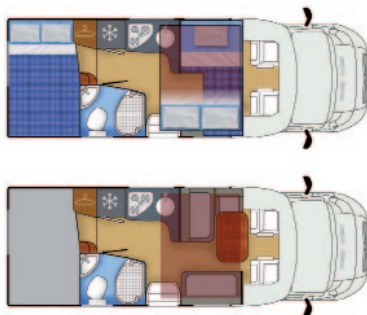

T-LOFT 45

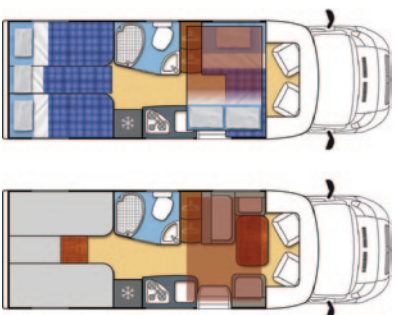

T-LOFT 53

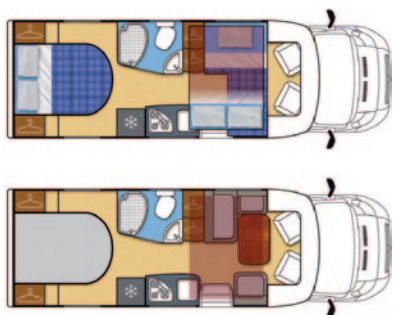

T-LOFT 58



elnagh

T-LOFT 53



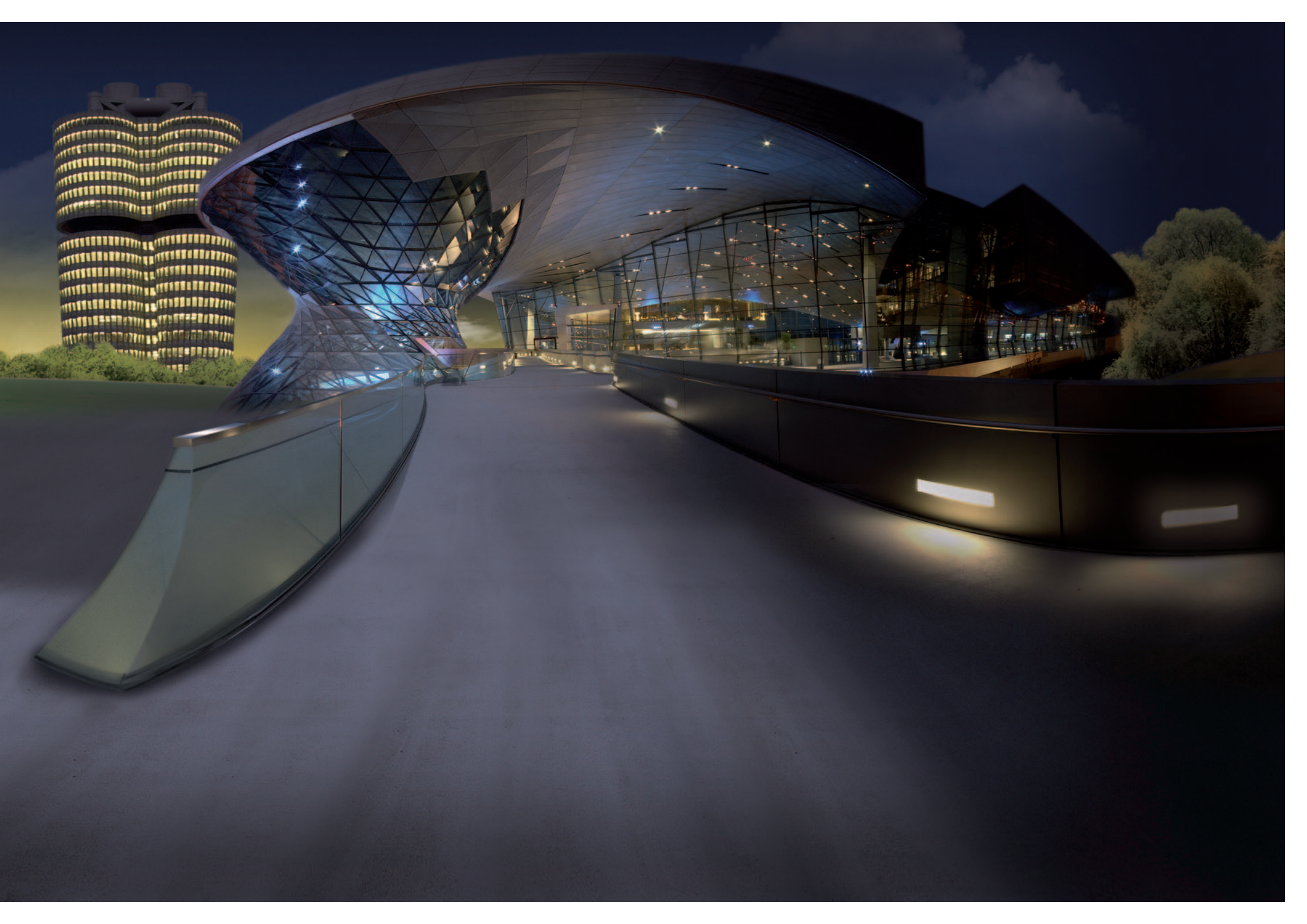

T-LOFT 53





T-LOFT 53





T-LOFT 53





T-LOFT 58



T-LOFT 53

PRINCE

PRINCE RANGE PLUS

Prince. The answer before the question is asked.

Elnagh knows its most demanding guests well. That's why it created Prince. Prince has everything you want for a perfect vacation: soft-lined décor, captivating colors, designer accessories. With Prince, your travels will have that extra something ... more style, more comfort, more vacation.



Wider track for secure road-holding and improved cornering stability.



Sleek, aerodynamic mansard. Pillar windows for greater visibility – an original Elnagh design.



Integrated, aerodynamic door hinge.

The characteristic design of the rear with tail lamps integrated into the bumper columns.



Nautical style for the modern canopy with built-in Sky – Dome.





Sky – Dome for enhanced interior luminosity, outfitted with blinds.



Functional folding extension to add a berth in the dinette.



Fiberglass kitchen counter with modern and functional design featuring capacious integrated sink.

Unparalleled comfort thanks to the telescoping table leg that can be shifted both horizontally and vertically.



Cupboard doors with lateral pistons for soft opening, in perfect automotive style.



Seitz door with integrated window and bug netting for enhanced interior livability.

PRINCE



Central control console with LCD screen. Interior and exterior temperature sensors.



New trimmer graphics with modern, dynamic design.



Branded hubcaps with raised Elnagh logo in resin.

New TV bracket with reinforced guides to reduce twisting and enhance stability.

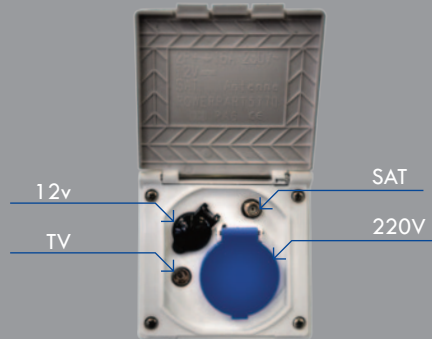

Multifunction external socket for TV, 12V, 220V and Satellite

Third brake light integrated into the design of the thermoformed rear.



Seitz windows with aluminum frame integrated into the design of the fiberglass sides.

Elegant resin lettering in relief.

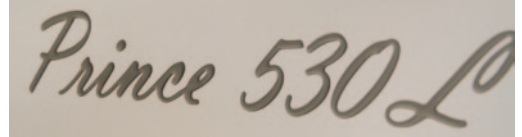

PRINCE RANGE COACHBUILT MODELS

PRINCE RANGE LOW PROFILE MODELS



PRINCE 46



PRINCE 47



PRINCE 55L



PRINCE 57



PRINCE 530L



PRINCE 580L



PRINCE 570L



PRINCE 581



PRINCE 590L

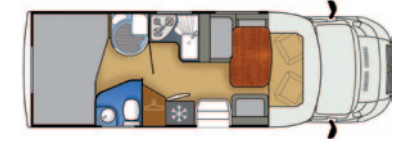

PRINCE 590L

PRINCE 590L



PRINCE 590L

PRINCE 590L



PRINCE 590L

PRINCE 590L



PRINCE 590L



elnagh

PRINCE 55L



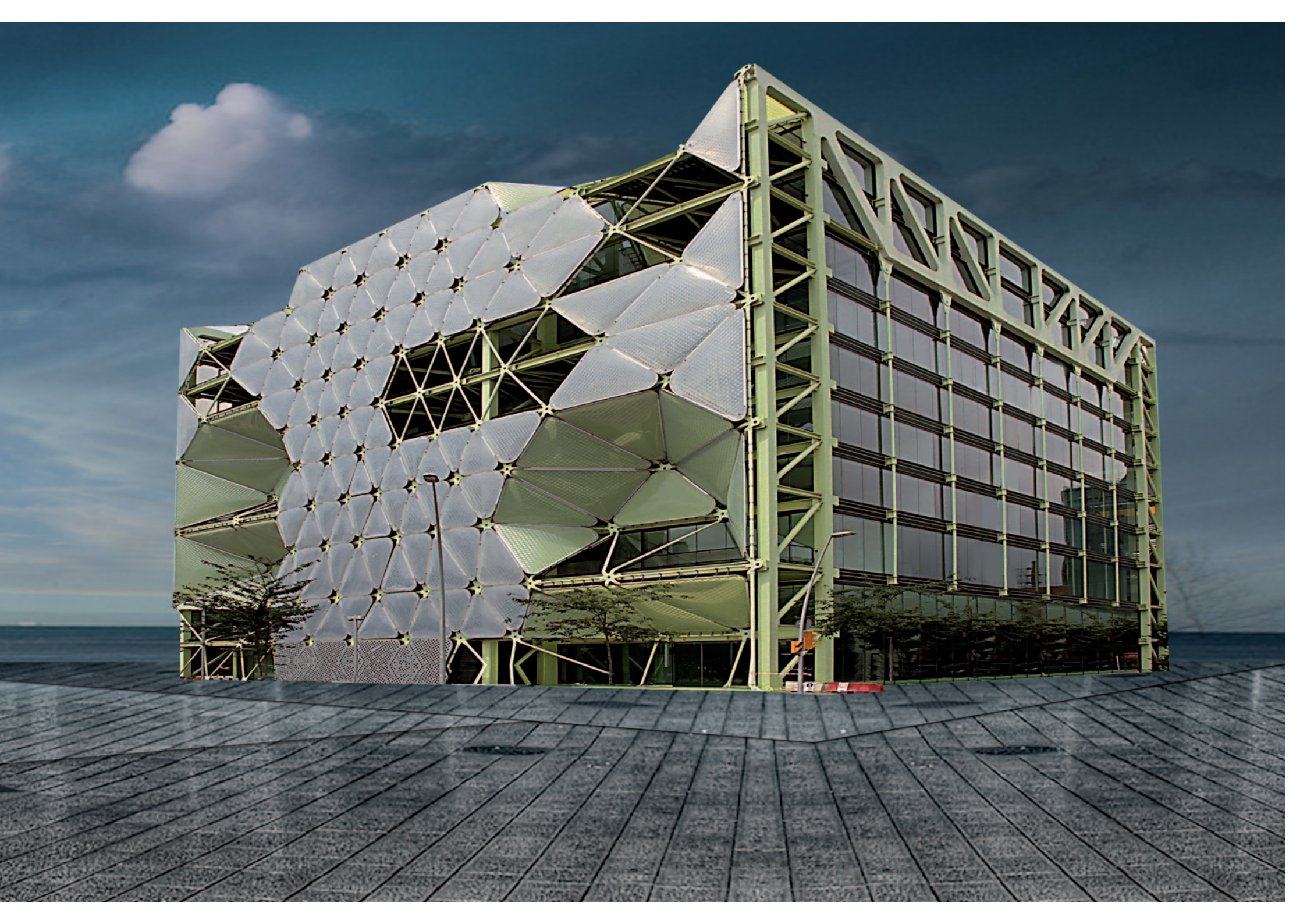

PRINCE 55L





PRINCE 55L





elnagh

PRINCE 530L





PRINCE 530L





PRINCE 530L





PRINCE 581





MAGNUM

MAGNUM RANGE PLUS

Leave your work, the city and the bustle behind. Climb into your Magnum and you're off!
With Magnum, you'll be sure to reach your destination because the first one is ... your Magnum!
Magnum is the Elnagh top of the line: majestic, elegant and hospitable.
If you want to have what others merely admire from the outside, choose Magnum.
Traveling with Magnum is an exclusive delight.
Business Class? No, Magnum Class!



The characteristic design of the rear with tail lamps integrated into the bumper columns.



Design headlights to improve the visibility whatever the season.



The ergonomical and comfortable Aguti seats, made with sweating materials, make you drive safer due to their internal reinforced structure and their integrated seat-belts.



Central control console with LCD screen.
Interior and exterior temperature sensors.



Branded hubcaps with raised Elnagh logo in resin.



Fiberglass kitchen counter with modern and functional design featuring spacious integrated sink.

Cupboard doors with lateral pistons for soft opening, in perfect automotive style.



New TV bracket with reinforced guides to reduce twisting and enhance stability.

Wider track for secure road-holding and improved cornering stability.

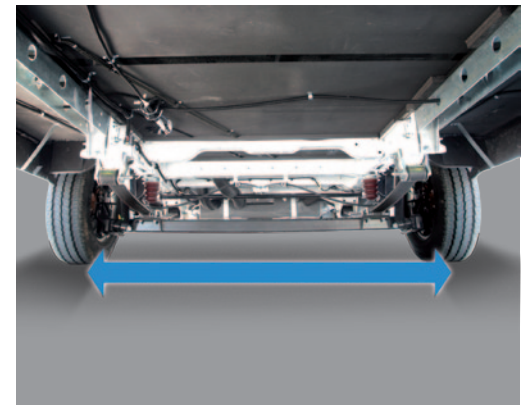

MAGNUM



Seitz door with integrated window and bug netting for enhanced interior livability.

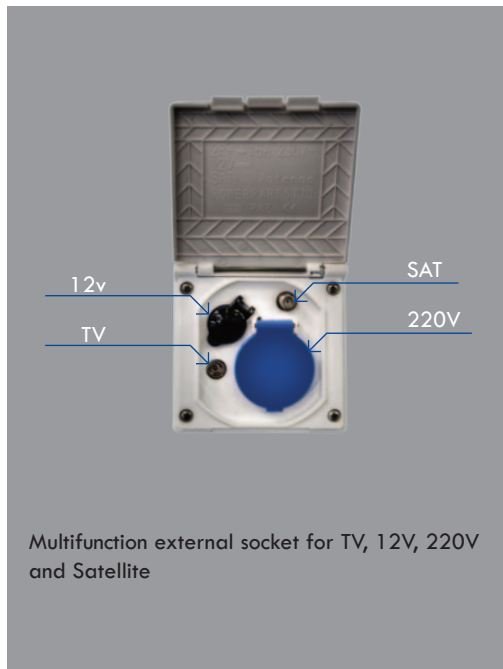

Third brake light integrated into the design of the thermoformed rear.



Seitz windows with aluminum frame integrated into the design of the fiberglass sides.

MAGNUM

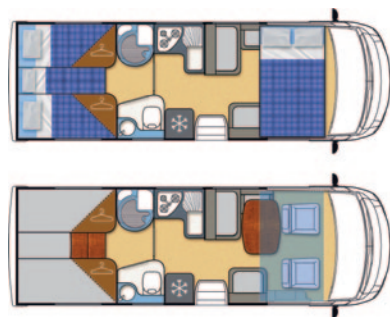

MAGNUM 30

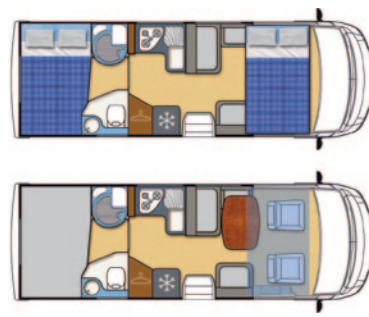

MAGNUM 70



elnagh

MAGNUM 30





MAGNUM 30





MAGNUM 30





MAGNUM 30





MAGNUM 30





SUMMARY LAYOUTS

BARON RANGE COACHBUILT MODELS



BARON 37



BARON 46



BARON 47D

BARON RANGE LOW PROFILE MODELS



BARON 420L



BARON 580L

DUKE RANGE COACHBUILT MODELS



DUKE 46



DUKE 57D



DUKE 55

T-LOFT RANGE LOW PROFILE MODELS



T-LOFT 31



T-LOFT 45



T-LOFT 53



T-LOFT 58

PRINCE RANGE COACHBUILT MODELS



PRINCE 46



PRINCE 47



PRINCE 55L



PRINCE 57

PRINCE RANGE LOW PROFILE MODELS



PRINCE 530L

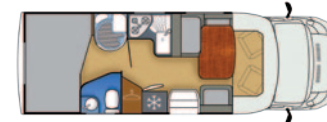

PRINCE 570L



PRINCE 580L



PRINCE 581



PRINCE 590L

MAGNUM RANGE MOTORHOME MODELS



MAGNUM 30



MAGNUM 70

STANDARD AND OPTIONAL EQUIPMENT ON ALL ELNAGH MODELS

STANDARD EQUIPMENT: STRUCTURE

FLOOR

THICKNESS: 70 mm

Specially projected to achieve high thermic and acoustic isolation. High results in strength and torsional performances.

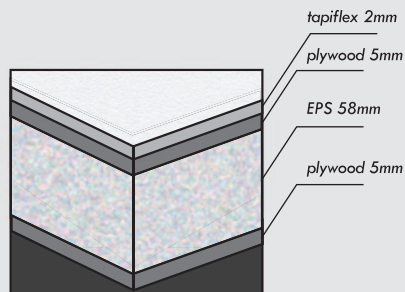

FIBREGLASS COATED WALLS AND ROOF

The materials combination used in the walls and roof production leads to the best results in terms of thermic and acoustic comfort as well as in terms of easy repair. The performance offered by the fibreglass is higher than the use of aluminium in which case the transmission level of heat, noise and cold is higher than when using the fibreglass.

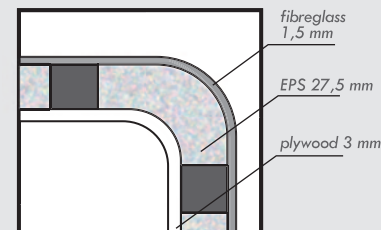

Advanced technology for the body and shell. Technical specifications of our all-composite shells:

- Resist mould and mildew
- Water-repellent
- Withstand high mechanical loads
- Fire and acid resistant
- May be used in temperatures between 50°C and +100°C
- Crush-proof
- Provide added insulation

STANDARD EQUIPMENT: BODY

- WARM AIR VENTILATION IN OVERCAB (COACHBUILT MODELS)
- HEATING WITH BLOWN AIR
- ELECTRICAL PANEL WITH BATTERY CHARGER
- 12V AND 220V TV-SAT SOCKET (INSIDE)
- 3 POINTS SEAT BELTS
- FRESH WATER TANK 100 L
- WASTE WATER TANK 100L
- SERVICE BATTERY COMPARTMENT
- EXTRACTABLE WC THETFORD CASSETTE
- EXTERNAL GAS BOTTLE LOCKER (2X13KG.)
- HIGH DENSITY BED MATTRESS
- OVERCAB BED PROTECTION NET (COACHBUILT MODELS)
- BUNK BEDS PROTECTION NET (WHEN FORESEEN)
- HOB WITH GLASS LID AND FLAME PROTECTION
- LADDER FOR OVERCAB BED (COACHBUILT MODELS)

OPTIONAL EQUIPMENT: BODY

- RAMP FOR ACCESS TO GARAGE STORAGE AREA (FOR MODELS WITH GARAGE)
- CORNER STEADIES
- CAB INSULATING MATS

STANDARD EQUIPMENT: CHASSIS

VERSION: FIAT X250 2.200cc - 100HP (74KW)

- POWER STEERING
- FRONT DRIVE
- DRIVER AIRBAG
- ABS
- INSULATING CAB WINDOWS
- ADJUSTABLE DRIVER AND PASSENGER SEATS
- HEIGHT ADJUSTABLE DRIVER SEAT
- ELECTRICALLY WINDOWS
- CAB CENTRAL LOCKING WITH REMOTE CONTROL
- DIESEL EXHAUST CLASSIFICATION EURO 4, 5 GEARS
- CAMPING CAR TYRES
- WIDER TRACK (EXCEPT BARON RANGE)
- CAB SEATS SWIVEL PLATES (LIVING MODELS)
- FIX & GO
- RADIO PRESETTING

VERSION: FIAT X250 2.300cc - 130HP (95,5KW) AND 3.000cc -157HP (115,5KW)

- IN ADDITION TO THE ABOVE MENTIONED EQUIPEMENT ON 100HP:
- DIESEL EXHAUST CLASSIFICATION EURO 4, 6 GEARS
- (1) ELEGANCE PACK (BARON 130HP, DUKE 130HP AND PRINCE)

OPTIONAL EQUIPMENT: CHASSIS

- AIR CONDITIONING IN CABIN
- CAB CARPET
- (1) ELEGANCE PACK (BARON 100HP)
- (2) SAFETY PACK (BARON 130HP, DUKE 130HP, PRINCE AND MAGNUM)
- WHITE REAR BUMPER (BARON AND DUKE)

(1) PACK ELEGANCE

- ELECTRICAL REAR VIEW MIRRORS WITH DEFROSTER
- RADIO AND LOUDSPEAKERS PRESETTING
- RADIO ANTENNA
- WHEEL TRIM
- CAB SEATS WITH DOUBLE ARMREST

(2) PACK SAFETY

- ASR
- PASSENGER'S AIRBAG
- CRUISE CONTROL

BARON

STANDARD AND OPTIONAL RANGE EQUIPMENT

STANDARD EQUIPMENT

HEATING AND WATER HEATER WITH ELECTRONIC IGNITION TRUMA C40
WINDOWS WITH DARKENER/MOSQUITO NET
3 SOCKETS (220V)
REAR BEDS WITH STAVES (420L AND 580L MODELS)
INSULATING MATS FOR CAB

OPTIONAL EQUIPMENT

EXTERNAL LIGHT
ENTRANCE DOOR WITH FLY SCREEN
ROOFLIGHT MIDI-HEKI, MANUALLY OPERATED (50X70CM)
CABIN SEATS COVERS IN THE SAME FABRIC AS UPHOLSTERY
ALUMINIUM ROOF-RACK WITH LADDER
DARKENER IN BATHROOM
CURTAIN BETWEEN LIVING QUARTERS AND CAB
LCD TV WALL UNIT WITH SLIDING BASE

DUKE/T-LOFT

STANDARD AND OPTIONAL RANGE EQUIPMENT

STANDARD EQUIPMENT

HEATING AND WATER HEATER WITH ELECTRONIC IGNITION TRUMA C40
EXTERNAL LIGHT
REAR BEDS WITH STAVES
OVERCAB BED AND OVERHEAD WITH STAVES
ROOFLIGHT MIDI-HEKI, MANUALLY OPERATED (50X70CM)
ROOFLIGHT (70X35 CM) FOR T-LOFT
ROOFLIGHT WITH 3-SPEED FAN (VENTILATOR / EXTRACTOR, OPT. T-LOFT MODELS)
SHOWER BOX WITH RIGID DOOR (SHOWER BOX FOR DUKE 55)
3 SOCKETS (220V)
12V AND 220V TV-SAT SOCKET (EXTERNAL)
DARKENER IN BATHROOM
WINDOWS WITH DARKENER/MOSQUITO NET (SEITZ)
CURTAIN BETWEEN LIVING QUARTERS AND CAB
LCD TV WALL UNIT WITH SLIDING BASE

OPTIONAL EQUIPMENT

ENTRANCE DOOR WITH FLY SCREEN
CABIN SEATS COVERS IN THE SAME FABRIC AS UPHOLSTERY
SIDE EXTERNAL LOCKER
ALUMINIUM ROOF-RACK WITH LADDER
GAS OVEN (T-LOFT 45, T-LOFT 53 AND COACHBUILT MODELS)

PRINCE

STANDARD AND OPTIONAL RANGE EQUIPMENT

STANDARD EQUIPMENT

HEATING WEBASTO AIR TOP 3900 EVO WITH ELECTRONIC IGNITION
WATER HEATER WITH ELECTRONIC IGNITION 10L.
EXTERNAL LIGHT
CABIN SEATS COVERS IN THE SAME FABRIC AS UPHOLSTERY
ENTRANCE DOOR WITH FLY SCREEN
WINDOWS WITH DARKENER/MOSQUITO NET (SEITZ)
"OPEN VIEW" SIDE COLUMNS FOR A PANORAMIC VIEW FROM LIVING AREA
ROOFLIGHT WITH 3-SPEED FAN (VENTILATOR / EXTRACTOR)
ROOFLIGHT MIDI-HEKI, MANUALLY OPERATED (50X70CM, LOW PROFILE MODELS)
ROOFLIGHT HEKI 2, MANUALLY OPERATED (60X90CM, COACHBUILT MODELS)
ROOFLIGHT "SKY DOME" (LOW PROFILE MODELS)
DARKENER IN BATHROOM
ROOFLIGHT IN BATHROOM
GAS OVEN
EXTRACTOR IN COOKING AREA
SHOWER BOX WITH RIGID DOOR
12V AND 220V TV-SAT SOCKET (EXTERNAL)
REAR BEDS WITH STAVES
OVERCAB BED WITH STAVES (COACHBUILT MODELS)
SIDE EXTERNAL LOCKER
CURTAIN BETWEEN LIVING QUARTERS AND CAB
PRE-SETTING FOR REAR-CAMERA AND REVERSION SENSOR
LCD TV WALL UNIT WITH SLIDING BASE

OPTIONAL EQUIPMENT

ENTRANCE DOOR WITH FLY SCREEN (SEITZ)
ALUMINIUM ROOF-RACK WITH LADDER
PRESTIGE UPHOLSTERY
REAR-CAMERA

MAGNUM

STANDARD AND OPTIONAL RANGE EQUIPMENT

STANDARD EQUIPMENT

HEATING WEBASTO AIR TOP 3900 EVO WITH ELECTRONIC IGNITION
WATER HEATER WITH ELECTRONIC IGNITION 10L.
EXTERNAL LIGHT
CABIN SEATS COVERS IN THE SAME FABRIC AS UPHOLSTERY
ENTRANCE DOOR WITH FLY SCREEN
WINDOWS WITH DARKENER/MOSQUITO NET (SEITZ)
ROOFLIGHT WITH 3-SPEED FAN (VENTILATOR / EXTRACTOR)
ROOFLIGHT MIDI-HEKI, MANUALLY OPERATED (50X70CM)
DARKENER IN BATHROOM
ROOFLIGHT IN BATHROOM
GAS OVEN
EXTRACTOR IN COOKING AREA
SHOWER BOX WITH RIGID DOOR
12V AND 220V TV-SAT SOCKET (EXTERNAL)
REAR BEDS WITH STAVES
TILT BED WITH STAVES
PRE-SETTING FOR REAR-CAMERA AND REVERSION SENSOR
LCD TV WALL UNIT WITH SLIDING BASE

OPTIONAL EQUIPMENT

ENTRANCE DOOR WITH FLY SCREEN (SEITZ)
ALUMINIUM ROOF-RACK WITH LADDER
PRESTIGE UPHOLSTERY
REAR-CAMERA

BARON RANGE COACHBUILT MODELS

BARON 37

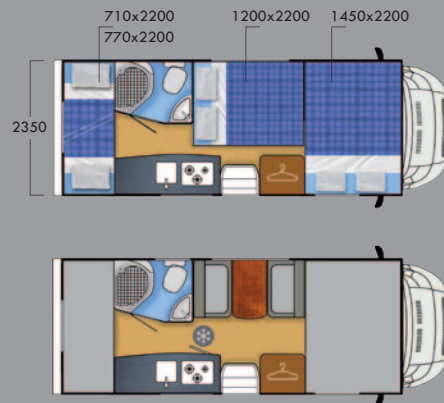
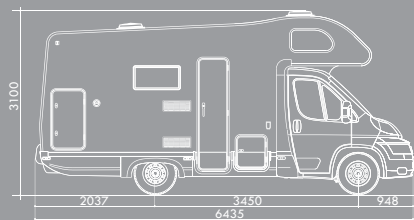

EC homologated places Sleeping capacity



Separate shower Garage with overturnable bed Refrigerator 117lt.

AVAILABLE MOTORIZATION	DUCATO 2.200 cc.	DUCATO 2.300 cc.
Wheel base mm.	3450	3450
Max. permitted loaded Mass kg.	3500	3500
Total Mass in running order kg	2952	2967
Max. user payload kg	548	533
Max. towing capacity kg (braked) (OPT)	2000	2000

BARON 46

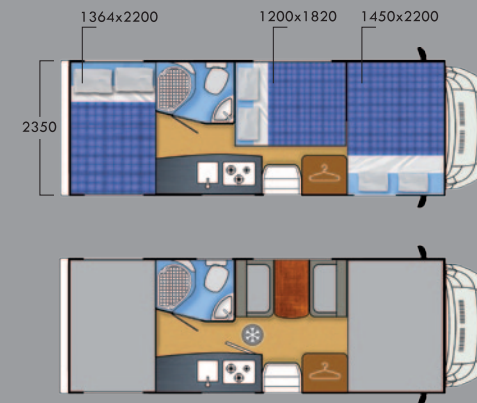
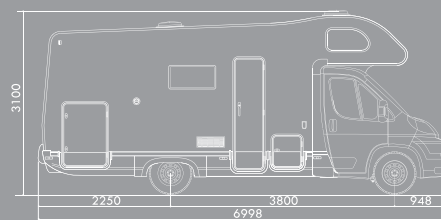

EC homologated places Sleeping capacity

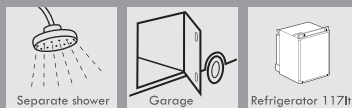

Separate shower Garage Refrigerator 117lt.

AVAILABLE MOTORIZATION	DUCATO 2.200 cc.	DUCATO 2.300 cc.
Wheel base mm.	3800	3800
Max. permitted loaded Mass kg.	3500	3500
Total Mass in running order kg	2937	2952
Max. user payload kg	563	548
Max. towing capacity kg (braked) (OPT)	2000	2000

BARON 47D

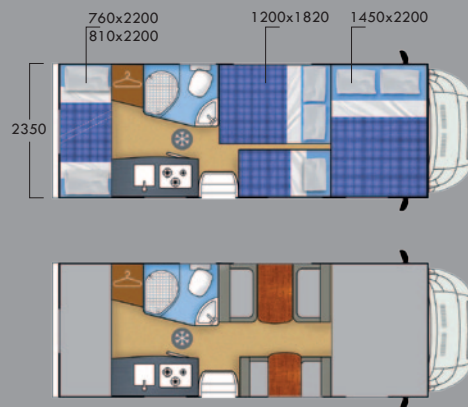
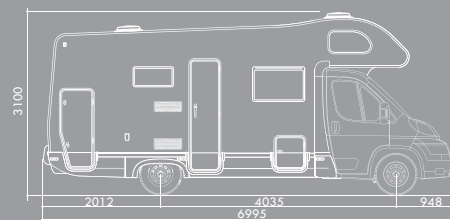

EC homologated places Sleeping capacity



Separate shower Garage with overturnable bed Refrigerator 117lt.

AVAILABLE MOTORIZATION	DUCATO 2.200 cc.	DUCATO 2.300 cc.
Wheel base mm.	4035	4035
Max. permitted loaded Mass kg.	3500	3500
Total Mass in running order kg	2892	2907
Max. user payload kg	608	593
Max. towing capacity kg (braked) (OPT)	2000	2000

BARON RANGE LOW PROFILE MODELS

BARON 420L

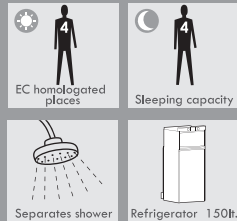
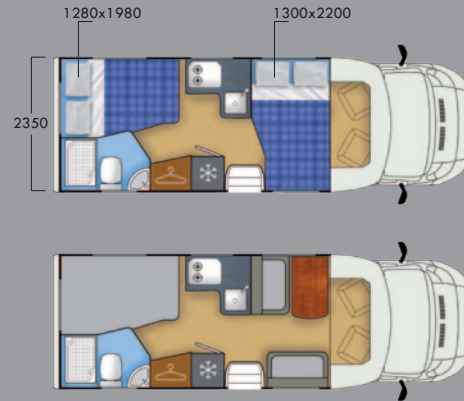
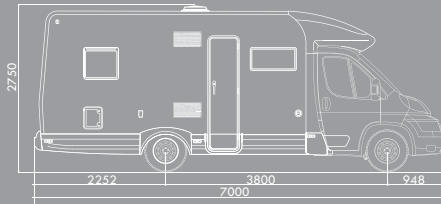

AVAILABLE MOTORIZATION	DUCATO 2.200 c.c.	DUCATO 2.300 c.c.
Wheel base mm.	3800	3800
Max. permitted loaded Mass kg.	3300	3300
Total Mass in running order kg	2916	2931
Max. user payload kg	384	369
Max. towing capacity kg (braked) (OPT)	2000	2000

BARON 580L

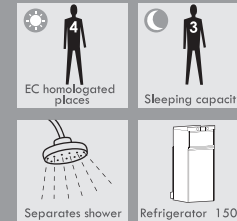
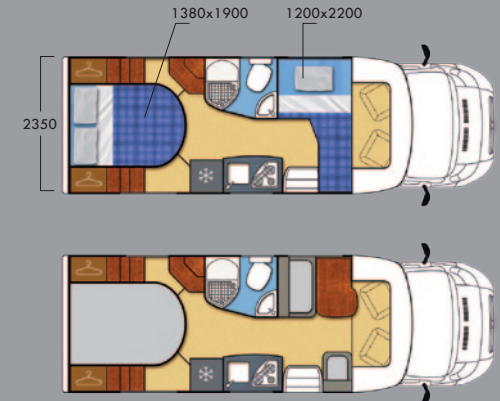
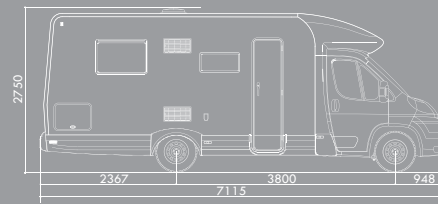

AVAILABLE MOTORIZATION	DUCATO 2.200 c.c.	DUCATO 2.300 c.c.
Wheel base mm.	3800	3800
Max. permitted loaded Mass kg.	3300	3300
Total Mass in running order kg	2775	2790
Max. user payload kg	525	510
Max. towing capacity kg (braked) (OPT)	2000	2000

DUKE RANGE COACHBUILT MODELS

DUKE 46

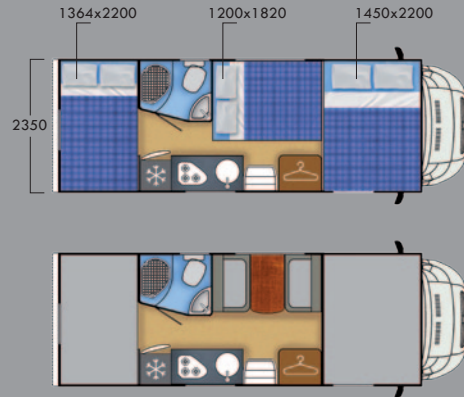
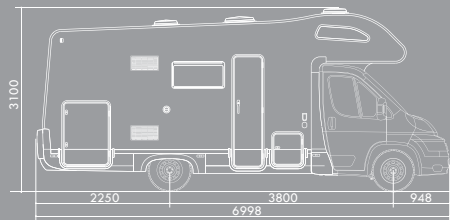

EC homologated places Sleeping capacity

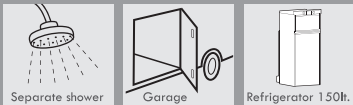

Separate shower Garage Refrigerator 150lt.

AVAILABLE MOTORIZATION	DUCATO 2.300 c.c.
Wheel base mm.	3800
Max. permitted loaded Mass kg.	3500
Total Mass in running order kg	2952
Max. user payload kg	548
Max. towing capacity kg (braked) (OPT)	2000

*IN SOME COUNTRIES THE HOMOLOGATION IS PROVIDED WITH REDUCED NUMBERS OF SEATS

DUKE 55

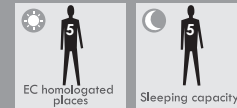
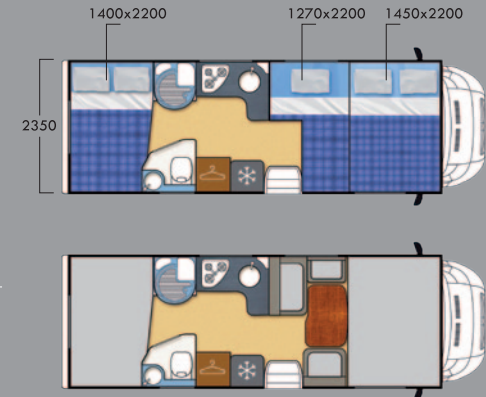
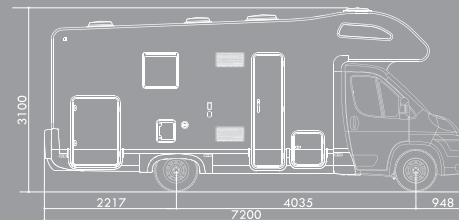

EC homologated places Sleeping capacity

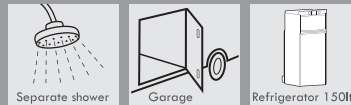

Separate shower Garage Refrigerator 150lt.

AVAILABLE MOTORIZATION	DUCATO 2.300 c.c.
Wheel base mm.	4035
Max. permitted loaded Mass kg.	3500
Total Mass in running order kg	3074
Max. user payload kg	426
Max. towing capacity kg (braked) (OPT)	2000

DUKE 57D

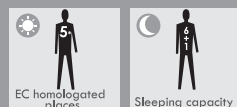
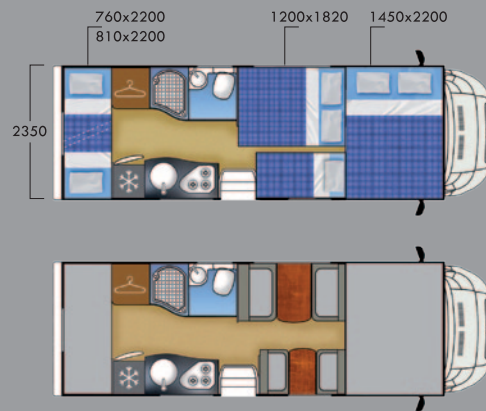
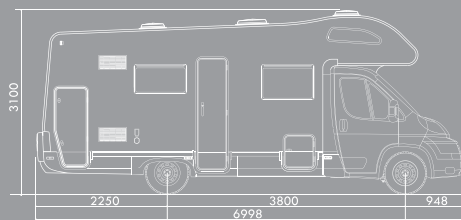

EC homologated places Sleeping capacity



Separate shower Garage with overturnable bed Refrigerator 150lt.

AVAILABLE MOTORIZATION	DUCATO 2.300 c.c.
Wheel base mm.	4035
Max. permitted loaded Mass kg.	3500
Total Mass in running order kg	3073
Max. user payload kg	427
Max. towing capacity kg (braked) (OPT)	2000

*IN SOME COUNTRIES THE HOMOLOGATION IS PROVIDED WITH REDUCED NUMBERS OF SEATS

T-LOFT RANGE LOW PROFILE MODELS

T-LOFT 31

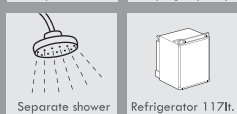
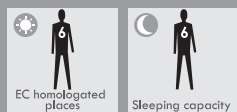
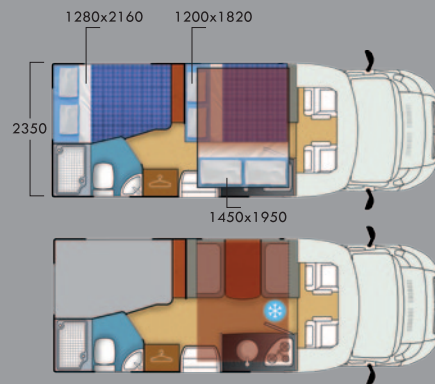
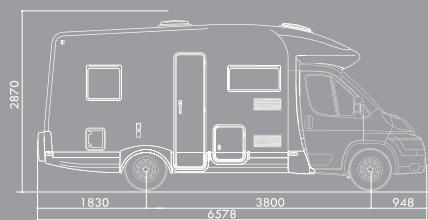

AVAILABLE MOTORIZATION	DUCATO 2.300 c.c.
Wheel base mm.	3800
Max. permitted loaded Mass kg.	3500
Total Mass in running order kg	2881
Max. user payload kg	619
Max. towing capacity kg (braked) (OPT)	2000

T-LOFT 45

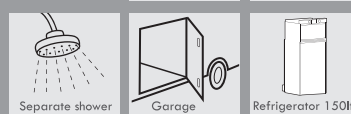
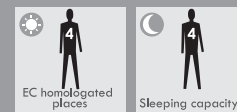
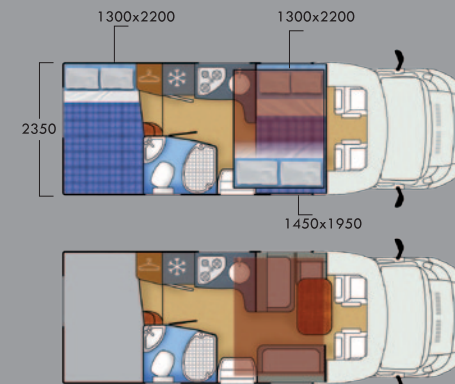
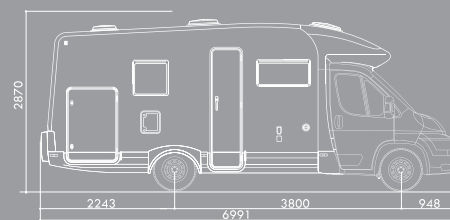

AVAILABLE MOTORIZATION	DUCATO 2.300 c.c.
Wheel base mm.	3800
Max. permitted loaded Mass kg.	3500
Total Mass in running order kg	2962
Max. user payload kg	538
Max. towing capacity kg (braked) (OPT)	2000

T-LOFT 53

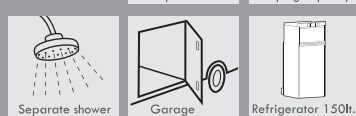
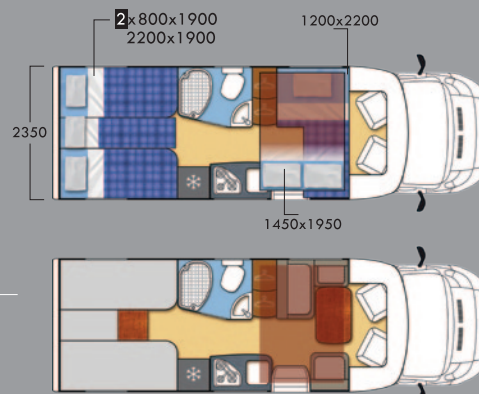
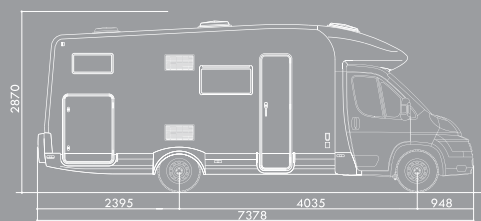

AVAILABLE MOTORIZATION	DUCATO 2.300 c.c.
Wheel base mm.	4035
Max. permitted loaded Mass kg.	3500
Total Mass in running order kg	3105
Max. user payload kg	395
Max. towing capacity kg (braked) (OPT)	2000

T-LOFT 58

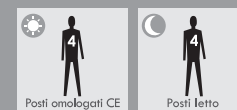
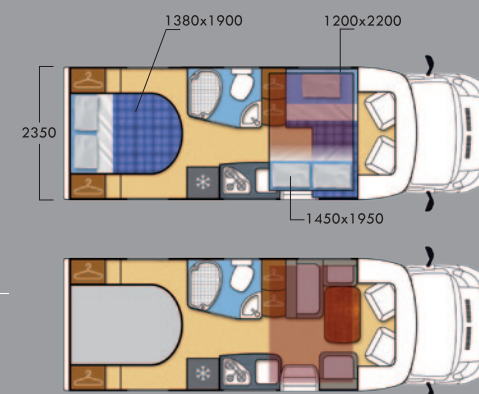
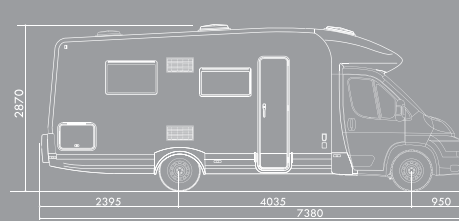

AVAILABLE MOTORIZATION	DUCATO 2.300 c.c.
Wheel base mm.	4035
Max. permitted loaded Mass kg.	3042
Total Mass in running order kg	2787
Max. user payload kg	458
Max. towing capacity kg (braked) (OPT)	2000

PRINCE RANGE COACHBUILT MODELS

PRINCE 46

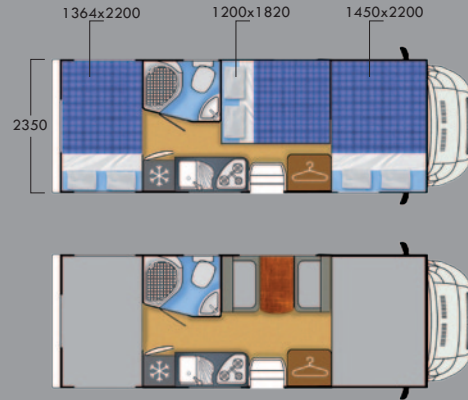
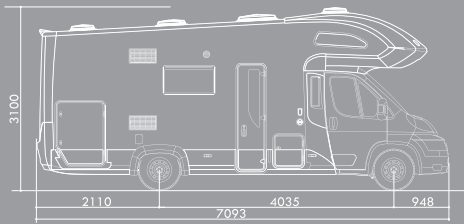

* 4 homologated seats in 160HP version

AVAILABLE MOTORIZATION	DUCATO 2.300 c.c.	DUCATO 3.000 c.c.
Wheel base mm.	4035	4035
Max. permitted loaded Mass kg.	3500	3500
Total Mass in running order kg	3066	3161
Max. user payload kg	434	339
Max. towing capacity kg (braked) (OPT)	2000	2000

PRINCE 47

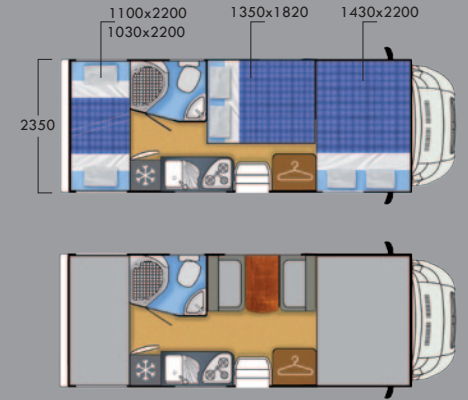
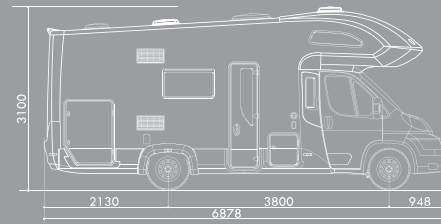

* 4 homologated seats in 160HP version

AVAILABLE MOTORIZATION	DUCATO 2.300 c.c.	DUCATO 3.000 c.c.
Wheel base mm.	3800	3800
Max. permitted loaded Mass kg.	3500	3500
Total Mass in running order kg	3068	3163
Max. user payload kg	432	337
Max. towing capacity kg (braked) (OPT)	2000	2000

PRINCE 55L

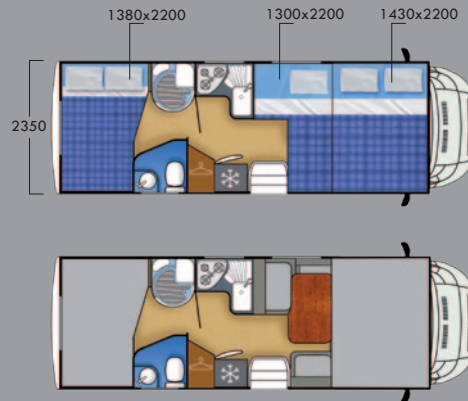
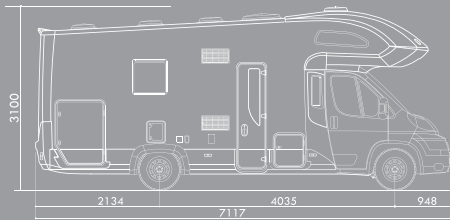

AVAILABLE MOTORIZATION	DUCATO 2.300 c.c.	DUCATO 3.000 c.c.
Wheel base mm.	4035	4035
Max. permitted loaded Mass kg.	3500	3500
Total Mass in running order kg	3130	3160
Max. user payload kg	370	340
Max. towing capacity kg (braked) (OPT)	2000	2000

PRINCE 57

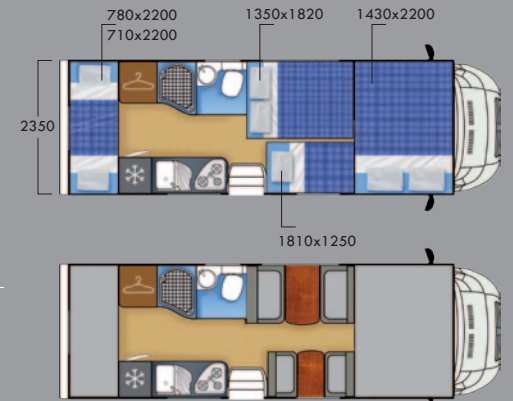
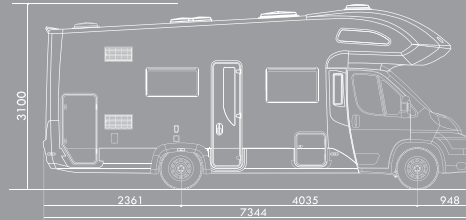

* 4 homologated seats in 160HP version

AVAILABLE MOTORIZATION	DUCATO 2.300 c.c.	DUCATO 3.000 c.c.
Wheel base mm.	4035	4035
Max. permitted loaded Mass kg.	3500	3500
Total Mass in running order kg	3073	3158
Max. user payload kg	427	342
Max. towing capacity kg (braked) (OPT)	2000	2000

PRINCE RANGE LOW PROFILE MODELS

PRINCE 530L

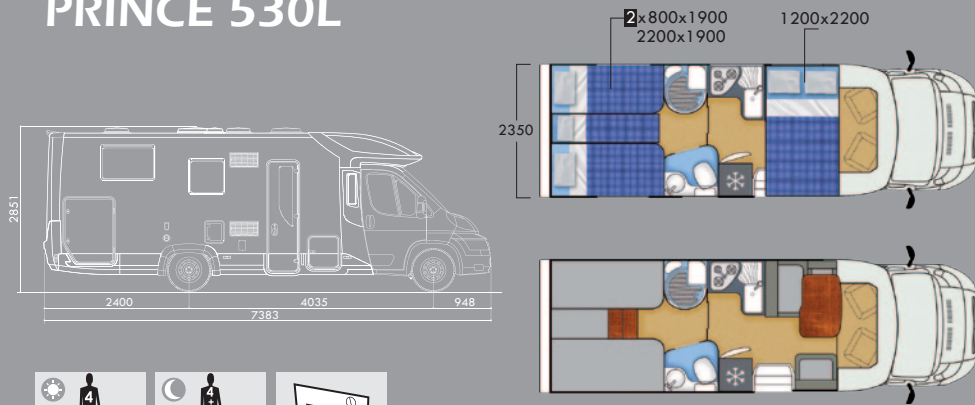

AVAILABLE MOTORIZATION	DUCATO 2.300 c.c.	DUCATO 3.000 c.c.
Wheel base mm.	4035	4035
Max. permitted loaded Mass kg.	3500	3500
Total Mass in running order kg	3111	3136
Max. user payload kg	389	364
Max. towing capacity kg (braked) (OPT)	2000	2000

PRINCE 570L

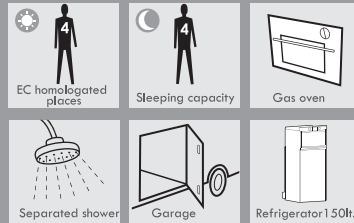
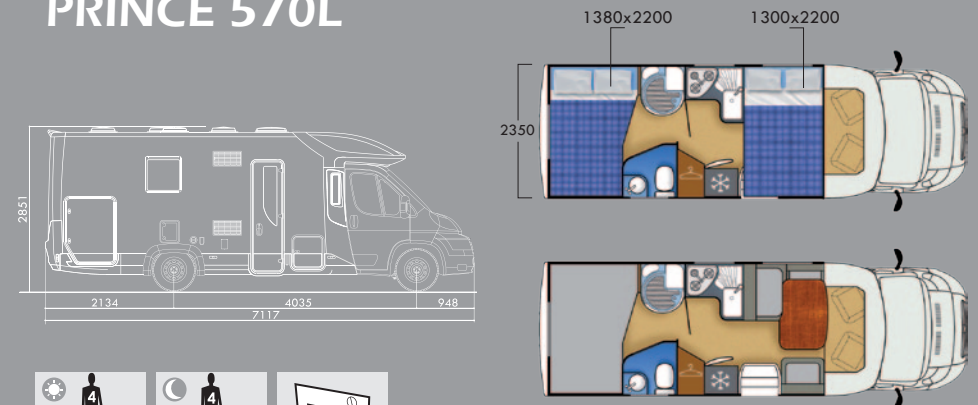

AVAILABLE MOTORIZATION	DUCATO 2.300 c.c.	DUCATO 3.000 c.c.
Wheel base mm.	4035	4035
Max. permitted loaded Mass kg.	3500	3500
Total Mass in running order kg	3053	3083
Max. user payload kg	447	417
Max. towing capacity kg (braked) (OPT)	2000	2000

PRINCE 580L

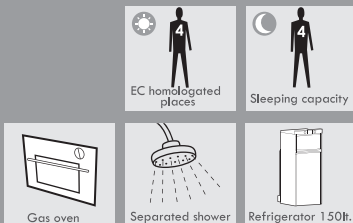
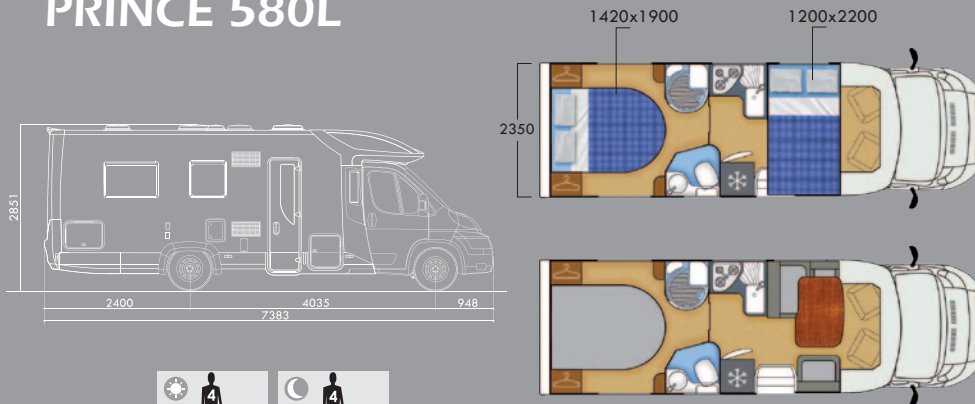

AVAILABLE MOTORIZATION	DUCATO 2.300 c.c.	DUCATO 3.000 c.c.
Wheel base mm.	4035	4035
Max. permitted loaded Mass kg.	3500	3500
Total Mass in running order kg	3098	3128
Max. user payload kg	402	372
Max. towing capacity kg (braked) (OPT)	2000	2000

PRINCE RANGE LOW PROFILE MODELS

PRINCE 581 L

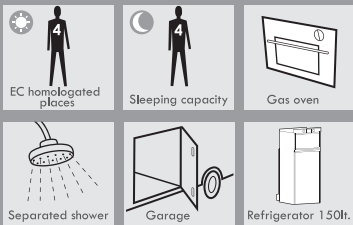
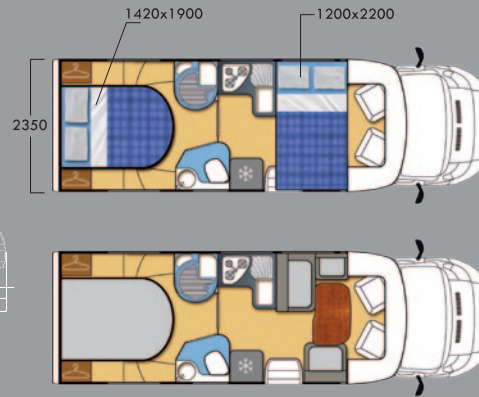
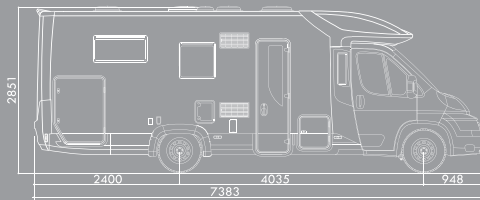

AVAILABLE MOTORIZATION	DUCATO 2.300 c.c.	DUCATO 3.000 c.c.
Wheel base mm.	4035	4035
Max. permitted loaded Mass kg.	3500	3500
Total Mass in running order kg	3094	3124
Max. user payload kg	406	376
Max. towing capacity kg (braked) (OPT)	2000	2000

PRINCE 590 L

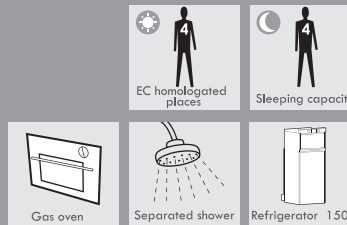
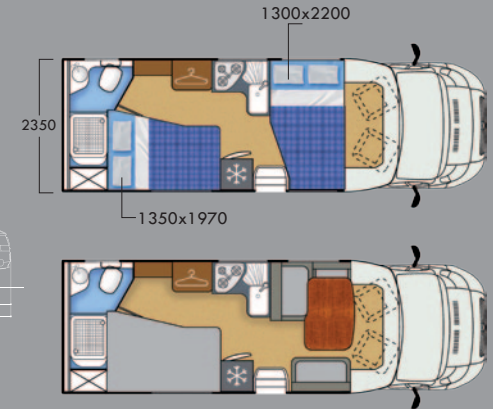
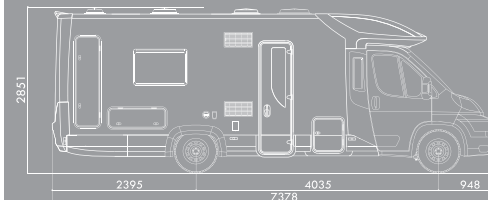

AVAILABLE MOTORIZATION	DUCATO 2.300 c.c.	DUCATO 3.000 c.c.
Wheel base mm.	4035	4035
Max. permitted loaded Mass kg.	3500	3500
Total Mass in running order kg	3080	3110
Max. user payload kg	420	390
Max. towing capacity kg (braked) (OPT)	2000	2000

MAGNUM RANGE INTEGRATED

MAGNUM 30

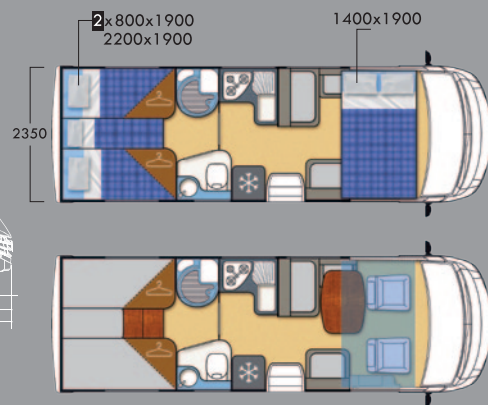
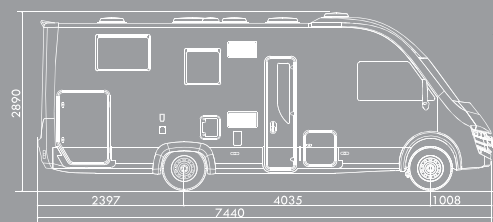

EC homologated places



Sleeping capacity



Gas oven



Separated shower



Garage



Refrigerator 150lt.

AVAILABLE MOTORIZATION

	DUCATO 2.300 cc.	DUCATO 3.000 cc.
Wheel base mm.	4035	4035
Max. permitted loaded Mass kg.	3500	3500
Total Mass in running order kg	3129	3159
Max. user payload kg	371	341
Max. towing capacity kg (braked) (OPT)	-	-

MAGNUM 70

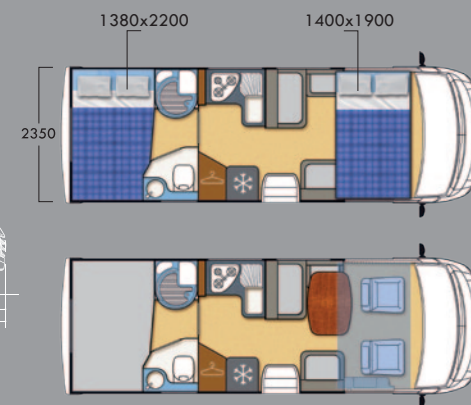
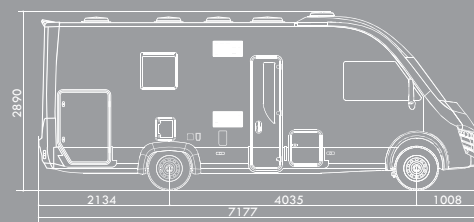

EC homologated places



Sleeping capacity

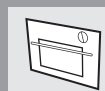

Gas oven



Separated shower



Garage

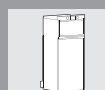

Refrigerator 150lt.

AVAILABLE MOTORIZATION

	DUCATO 2.300 cc.	DUCATO 3.000 cc.
Wheel base mm.	4035	4035
Max. permitted loaded Mass kg.	3500	3500
Total Mass in running order kg	3126	3156
Max. user payload kg	374	344
Max. towing capacity kg (braked) (OPT)	-	-

All calculations of the masses mentioned in this catalogue are made according to the European Directive 95/48 CE and to the European Norm EN 1646 – 2 Standard.

TOTAL MASS IN RUNNING ORDER

It includes: base vehicle's weight (empty), driver, fuel, lubricants, cooling fluids, tools, gas bottles, fresh water tank. Some models have a clear waters load limitation (see label on loading point).

MAX PAYLOAD

Difference between the maximum technically admitted laden mass and the mass in running order.

It includes: passengers' weight excluded the driver, luggage and personal belongings.

All masses and weights are subject to a tolerance of +/- 5% complying with the European Directive 95/48/CE.

The installation of optionals or additional equipment reduces the maximum payload of the vehicle accordingly.

The total mass in running order indicated in this catalogue refers to the standard basic vehicle and it excludes the weight of any optional equipment.

In case of installation of additional overhanging appendixes such as towing hook or motorbike carrier the number of homologated places may vary depending on the specific circulation laws of each single country.

The drinking water installation fits the state of the art of the technique 03/2009 (Law 2002/72/EEC).

SEA S.P.A. – Elnagh reserves the right to modify, without any prior notice, the technical features and any other specification of its product range; all data included in present catalogue are to be considered indicative and not binding.



SEA, A SOLID INDUSTRIAL GROUP

SEA is one of the principal European camper manufacturers, and groups together some of the leading names in the sector, active for over 60 years. The wide recognition of the SEA brands and their continued appreciation over the years, coupled with its vast fleet of circulating vehicles, guarantee our clients an exceptional vehicle value retention over time.

Thanks to its solid organisational structure, SEA is able to deliver products and services characterised by the utmost quality, professionalism and care: SEA fulfils the client's expectations with competence and dedication.

An ongoing process of searching for and selecting the finest suppliers, coupled with quality assured through tests and inspections at every stage of the production process, guarantee maximum reliability of the vehicles. The SEA group vehicles are produced in state-of-the-art facilities, through an industrialised production process in which the skills of individual operators and craftsmanlike attention detail confer an added value and quality differential.

The day-to-day work of our research and development centres makes it possible to introduce novel technologies and innovative solutions designed to continually improve the products' performance.



INDUSTRIAL PARK POGGIBONSI (TOSCANA)

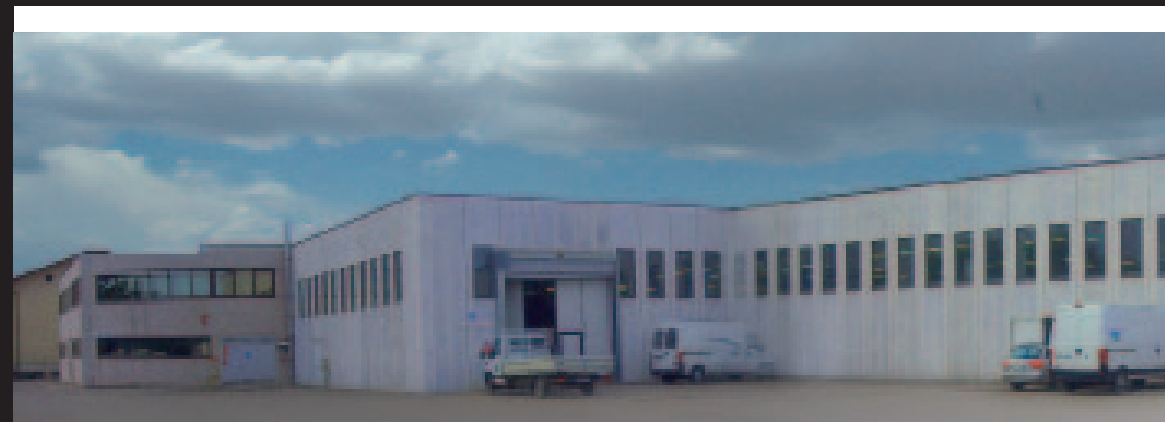

INDUSTRIAL PARK SAN GIUSTINO (PERUGIA)

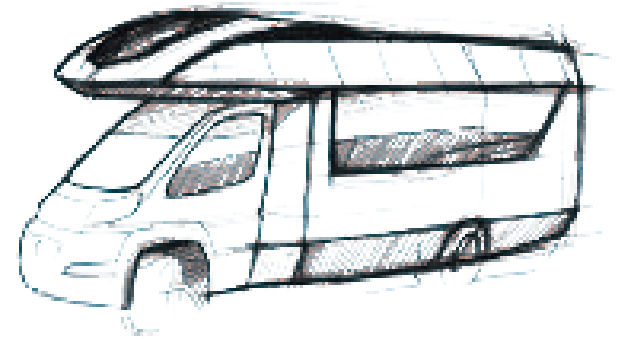

INDUSTRIAL PARK TRIVOLZIO (LOMBARDIA)

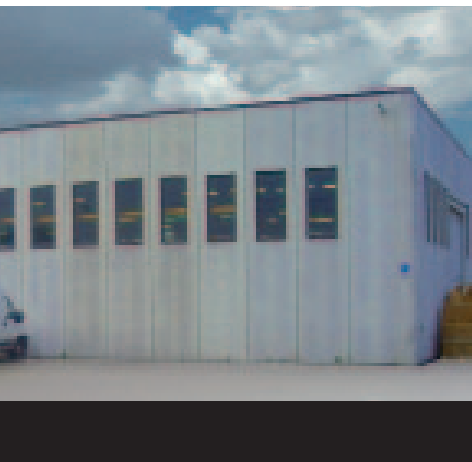



SEA S.p.A. - Elnagh reserves the right to modify, without any prior notice, the technical characteristics and the furniture of each of its models; all the data included in the present catalogue are to be considered indicative and not binding.



V.le Dell' Industria, 6 - 27020 Trivulzio (PV) Italia - Tel.+39 03824530.1 - Fax+39 03824530.550 - info@elnagh.it

www.elnagh.it